



Lifestyle
Collection
N.2

marelli

Lifestyle Collection N.2

marelli

RUBELLI

DOMINIQUE
Kieffer
BY RUBELLI

DESIGNERS GUILD

SAHCO

CASAMANCE

ROMO

MISIA
PARIS

kirkbydesign

DEDAR
MILANO



ZIMMER+ROHDE

Indice prodotti

PRODUCT LIST

Divani

SOFAS

Andy
PAGE 63 | 77 | 89



Clipper
PAGE 95



Gary
PAGE 63 | 77



Lancaster
PAGE 169



Matheus
PAGE 155 | 163



Moon
PAGE 131 | 141 | 149 | 233 | 239



Noah
PAGE 9 | 33 | 39



Richard
PAGE 177 | 183 | 189 | 197



Ritz
PAGE 215 | 223



Sign
PAGE 107



Sedie e poltrone

CHAIRS AND ARMCHAIRS

Chia
PAGE 25 | 47



Brera
PAGE 63 | 155



Clipper
PAGE 95 | 177 | 197 | 207



Clipper Chair
PAGE 83



Linda
PAGE 9 | 53



Moon
PAGE 131 | 141



Nicole
PAGE 95



Noah
PAGE 9



Ritz
PAGE 223



Sign
PAGE 107 | 131 | 149 | 189



Pouf

OTTOMANS

Moon
PAGE 239



Tavoli da Pranzo

DINING TABLES

Anderson
PAGE 83



Mike
PAGE 95



Onno
PAGE 9 | 53



Wave
PAGE 25 | 47



Madie e Credenze

SIDEBOARDS AND CUPBOARDS

George
PAGE 9



Kyoto
PAGE 39 | 89 | 189 | 215



Reflex
PAGE 9 | 77



Specchi

MIRROR

Tavolini

COFFEE TABLES

Arthur
PAGE 9 | 145 | 223 | 233



Atene
PAGE 9 | 33 | 39 | 89 | 131 | 141 | 155



Break
PAGE 207



Clip
PAGE 25 | 163 | 197 | 223 | 239



Frame
PAGE 169 | 177 | 197 | 207



Kyoto
PAGE 107



Leaf
PAGE 63 | 77 | 163



Mini
PAGE 215



Thor
PAGE 63 | 77 | 155 | 163 | 169 | 197



Twig
PAGE 163 | 223



Wave
PAGE 63 | 95 | 149 | 183 | 189 | 215





NOAH sofa 9NH202 cm 250x100x80h | Fabric: cat. F/G art. Misa Aime col. M188 622 Badiane | Cushions: 1 x cushion 9CU106 cm 45x45 Fabric: cat. F/G art. Misa Aime col. M188 622 Badiane | 2 x cushions 9CU106 cm 45x45 Fabric: cat. D/E art. Tresigallo col. 08 **NOAH curved sofa** 9NH301 cm 250x110x80h Fabric: cat. D/E art. Tresigallo col. 13 | 2 x cushions 9CU106 cm 45x45 Fabric: cat. D/E art. Tresigallo col. 13 | 1 x cushion 9CU106 cm 45x45 Fabric: cat. H art. Rubelli Spritz col. 25 lichene **ARTHUR side tables** 7ART201 ø cm 50x50h | 7ART202 ø cm 60x40h | 7ART203 ø cm 120x30h | Top: OPP7 Calacatta marble | Base: OPM20 Delabré brass brushed metal **GEORGE sideboard** 7GE201 cm 220x50x71h | Wooden structure: OPR15 moka matt stained oak | Top: OPP7 Calacatta marble | Base: OPM15 antique gold brushed metal **REFLEX mirror** 7RE106 ø 120x8 Bronze mirror OPM15 antique gold brushed metal frame

marelli



NOAH sofa 9NH202 cm 250x100x80h | Fabric: cat. F/G art. Misa Aime col. M188 622 Badiane | Cushions: 1 x cushion 9CU106 cm 45x45 Fabric: cat. F/G art. Misa Aime col. M188 622 Badiane | 2 x cushions 9CU106 cm 45x45 Fabric: cat. D/E art. Tresigallo col. 08 **ATENE coffee tables** 7AT104 ø cm 100x30h | 7AT101 ø cm 50x40h | Top: OPP3 Emperador brown marble | Base: OPM17 bronze metal



NOAH sofa 9NH202 cm 250x100x80h | Fabric: cat. F/G art. Misia Aime col. M188 622 Badiane | Cushions: 1 x cushion 9CU106 cm 45x45 | Fabric: cat. F/G art. Misia Aime col. M188 622 Badiane | 1 x cushion 9CU106 cm 45x45 | Fabric: cat. D/E art. Tresigallo col. 08 | 1 x cushion 9CU106 cm 45x45 | Fabric: Misia Azur Cotonneux M282 204 Mordoré | 1 x cushion 9CU107 cm 25x50 | Fabric: cat. H art. Casamance Lanata 4454 09 60 **NOAH Armchair** 9NH101 cm 90x90x76,5h **NOAH curved sofa** 9NH301 cm 250x110x80h | Fabric: cat. D/E art. Tresigallo col. 08 | Cushions: 1 x cushion 9CU106 cm 45x45 | Fabric: cat. F/G art. Misia Aime col. M188 622 Badiane | 1 x cushion 9CU106 cm 45x45 | Fabric: cat. D/E art. Tresigallo col. 08 | 1 x cushion 9CU106 cm 45x45 | Fabric: cat. H art. Casamance Lanata 4454 09 60 **ATENE coffee tables** 7AT104 ø cm 100x30h | 7AT101 ø cm 50x40h | Top: OPP3 Emperador brown marble | Base: OPM17 bronze metal



NOAH curved sofa 9NH301 cm 250x110x80h | Fabric: cat. D/E art. Tresigallo col. 13 | Cushions: 2 x cushions 9CU106 cm 45x45 | Fabric: cat. D/E art. Tresigallo col. 13 | 1 x cushion 9CU106 cm 45x45 | Fabric: cat. H art. Rubelli Spritz col. 25 lichene **ARTHUR side tables** 7ART201 ø cm 50x50h | 7ART202 ø cm 60x40h | Top: OPP7 Calacatta marble | Base: OPM20 Delabré brass brushed metal



Detail of **NOAH** sofa and **ARTHUR** side tables with OPP7 Calacatta marble top and OPM20 délabré brass brushed metal

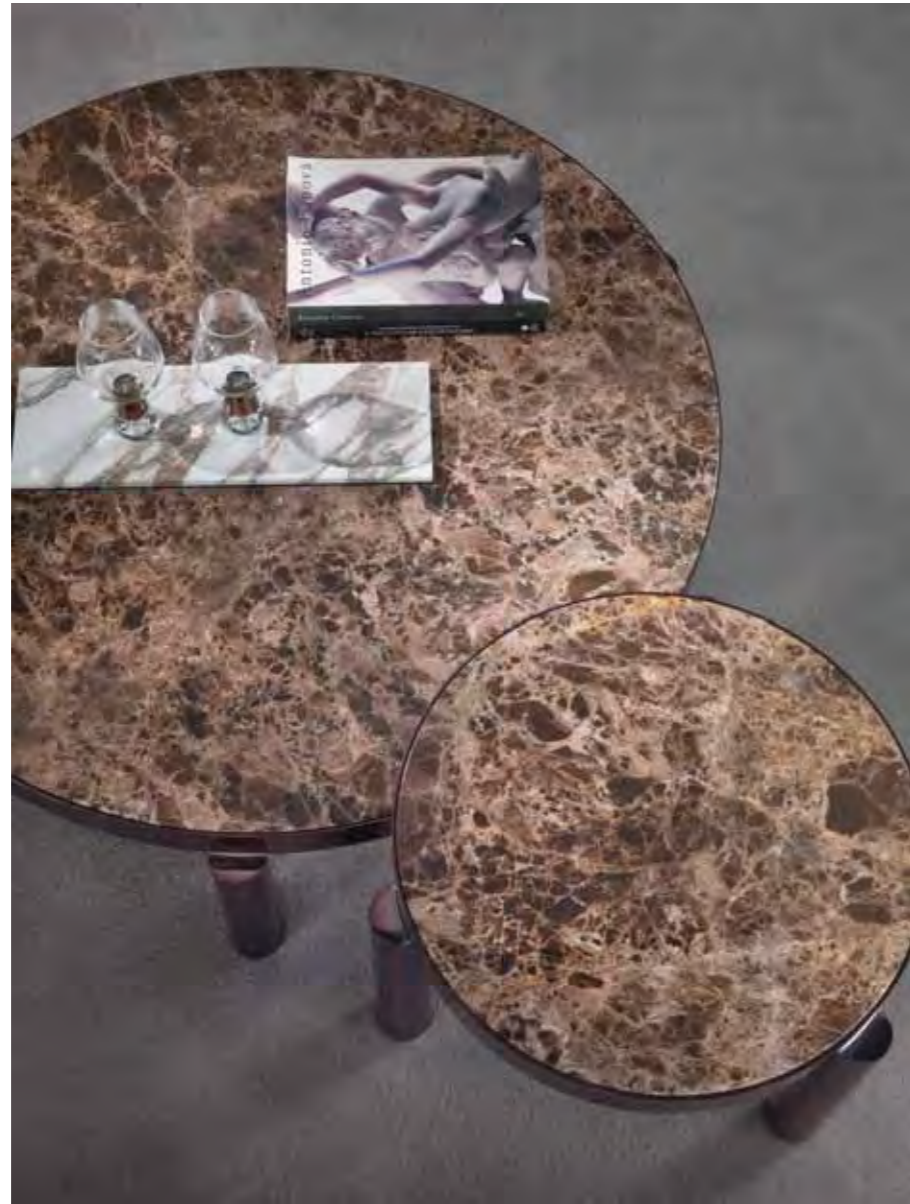

ATENE coffee tables 7AT104 ø cm 100x30h | 7AT101 ø cm 50x40h | Top: OPP3 Emperador brown marble | Base: OPM17 bronze metal
 > **NOAH Armchair** 9NH101 cm 90x90x76,5h | Fabric: cat. D/E art. Tresigallo col. 08 **ATENE coffee table** 7AT101 ø cm 50x40h | Top: OPP3 Emperador brown marble
 | Base: OPM17 bronze metal





GEORGE sideboard 7GE201 cm 220x50x71h | Wooden structure: OPR15 moka matt stained oak | Top: OPP7 Calacatta marble | Base: OPM15 antique gold brushed metal **REFLEX mirror** 7RE106 ø 120x8 Bronze mirror OPM15 antique gold brushed metal frame



Detail of **GEORGE sideboard** with OPP7 Calacatta marble top



Wave Dining Table | Chia

WAVE dining table 7WA201 cm 260x110x74h | Top: OPP13 Velvet Brown marble top | Base: OPP20 Delabré brass brushed metal **CHIA chairs** 9CHI104 cm 58x53x77h
 | Outer side: leather cat. Lusso art. Nabuk col. C3407 Mogano | Inner side: fabric cat. F/G art. Misia Aime col. M188 705 Mordoré | Base: OPM15 antique gold brushed metal

marelli



WAVE dining table 7WA201 cm 260x110x74h | Top: OPP13 Velvet Brown marble top | Base: OPP20 Delabré brass brushed metal **CHIA chairs** 9CHI104 cm 58x53x77h
| Outer side: leather cat. Lusso art. Nabuk col. C3407 Mogano | Inner side: fabric cat. F/G art. Misia Aime col. M188 705 Mordoré | Base: OPM15 antique gold brushed metal



Detail of OPP13 Velvet Brown marble

> **WAVE dining table** 7WA201 cm 260x110x74h | Top: OPP13 Velvet Brown marble top | Base: OPP20 Delabré brass brushed metal **CHIA chairs** 9CHI104 cm 58x53x77h | Outer side: leather cat. Lusso art. Nabuk col. C3407 Mogano | Inner side: fabric cat. F/G art. Misia Aime col. M188 705 Mordoré | Base: OPM15 antique gold brushed metal







Noah | Atene

NOAH chaise longue 9NH102 cm 220x100x80h | Fabric: cat. C art. Koala col. 107 | Cushions: 2 x cushions 9CU106 cm 45x45 | Fabric: cat. C art. Koala col. 107 | 1 x cushion 9CU106 cm 45x45 | Fabric: cat. H art. Misia M261 8 01 Ivoire **ATENE coffee tables**: 7AT104 ø cm 100x30h | Base: OPM15 antique gold brushed metal | Top: OPP7 Calacatta marble | 7AT111 ø cm 50x40h | Base: OPM15 antique gold brushed metal | Top: OPV9 chrome back-painted bronze glass

marelli



NOAH chaise longue 9NH102 cm 220x100x80h | Fabric: cat. C art. Koala col. 107 | Cushions: 1 x cushion 9CU106 cm 45x45 | Fabric: cat. C art. Koala col. 107 | 1 x cushion 9CU106 cm 45x45 | Fabric: cat. H art. Misia M261 8 01 Ivoire



NOAH chaise longue 9NH102 cm 220x100x80h | Fabric: cat. C art. Koala col. 107 | Cushions: 1 x cushion 9CU106 cm 45x45 | Fabric: cat. C art. Koala col. 107 | 1 x cushion 9CU106 cm 45x45 | Fabric: cat. H art. Misia M261 8 01 Ivoire



NOAH curved sofa 9NH301 cm 250x100x80h | Fabric: cat. H art. Dedar Belsuede col. 004 deserto | Cushions: 1 x cushion 9CU106 cm 45x45 | Fabric: cat. D/E art. Tresigallo col. 13 | 1 x cushion 9CU106 cm 45x45 | Fabric: cat. H art. Rubelli Spritz col. 25 lichene **NOAH curved sofa** 9NH301 cm 250x100x80h | Fabric: cat. F/G art. Orsetto col. 09/23 **ATENE coffee tables**: 7AT104 ø cm 100x30h | Base: OPM15 antique gold brushed metal | Top: OPP7 Calacatta marble | 7AT111 ø cm 50x40h | Base: OPM15 antique gold brushed metal | Top: OPV9 chrome back-painted bronze glass **KYOTO sideboard** 7KY212 cm 220x50x71h | Wooden structure: OPR15 moka matt stained oak | Top: OPP7 Calacatta marble | Base: OPM15 antique gold brushed metal



ATENE coffee tables 7AT104 ø cm 100x30h | Base: OPM15 antique gold brushed metal | Top: OPP7 Calacatta marble | 7AT111 ø cm 50x40h | Base: OPM15 antique gold brushed metal | Top: OPV9 chrome back-painted bronze glass **KYOTO sideboard** 7KY212 cm 220x50x71h | Wooden structure: OPR15 moka matt stained oak | Top: OPP7 Calacatta marble | Base: OPM15 antique gold brushed metal



Detail of **NOAH sofa** in fabric cat. H art. Dedar Belsuede col. 004 Deserto





Wave Dining Table | Chia

WAVE round dining table 7WA204 ø cm 160x74h | Base: OPM20 Délabré brass brushed metal | Top: OPP7 Calacatta marble **CHIA chairs** 9CHI104 cm 58x53x77h
 | Outside: leather cat. Super art. Dollaro 7739 | Inside: fabric cat. H art. Casamance Alma beige taupe | Base: OPM15 antique gold brushed metal

marelli



WAVE round dining table 7WA204 ø cm 160x74h | Base: OPM20 Délabré brass brushed metal | Top: OPP7 Calacatta marble **CHIA chairs** 9CHI104 cm 58x53x77h
| Outside: leather cat. Super art. Dollaro 7739 | Inside: fabric cat. H art. Casamance Alma beige taupe | Base: OPM15 antique gold brushed metal



WAVE round dining table 7WA204 ø cm 160x74h | Base: OPM20 Délabré brass brushed metal | Top: OPP7 Calacatta marble **CHIA chairs** 9CHI104 cm 58x53x77h
 | Outside: leather cat. Super art. Dollaro 7739 | Inside: fabric cat. H art. Casamance Alma beige taupe | Base: OPM15 antique gold brushed metal



Onno | Linda

ONNO dining table 70N201 cm 260x120x74h | Top: OPP7 Calacatta marble | Base: OPR15 moka matt stained oak **LINDA chairs** 9LIN102 cm 62x58x78h | Fabric: cat.
H art. Sahco Zero col. 001 | Base: OPM15 antique gold brushed metal

marelli



ONNO dining table 70N201 cm 260x120x74h | Top: OPP7 Calacatta marble | Base: OPR15 moka matt stained oak **LINDA chairs** 9LIN102 cm 62x58x78h | Fabric: cat. H art. Sahco Zero col. 001 | Base: OPM15 antique gold brushed metal

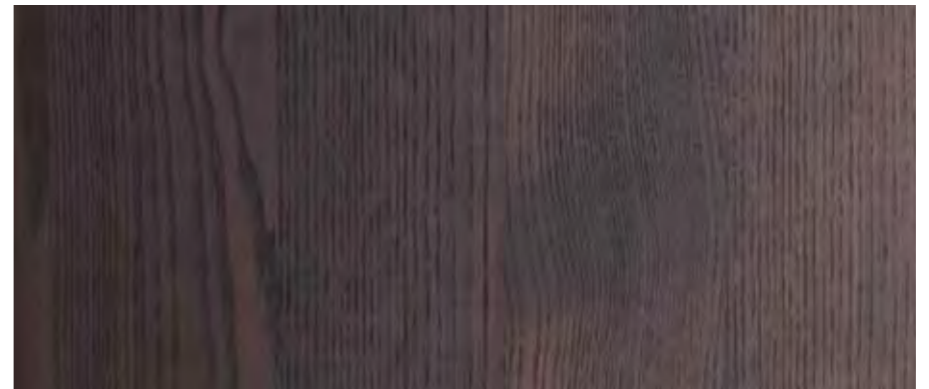

Details of OPR15 moka matt stained oak and OPP7 Calacatta marble finishes



LINDA chairs 9LIN102 cm 62x58x78h | Fabric: cat. H art. Sahco Zero col. 001 | Base: OPM15 antique gold brushed metal

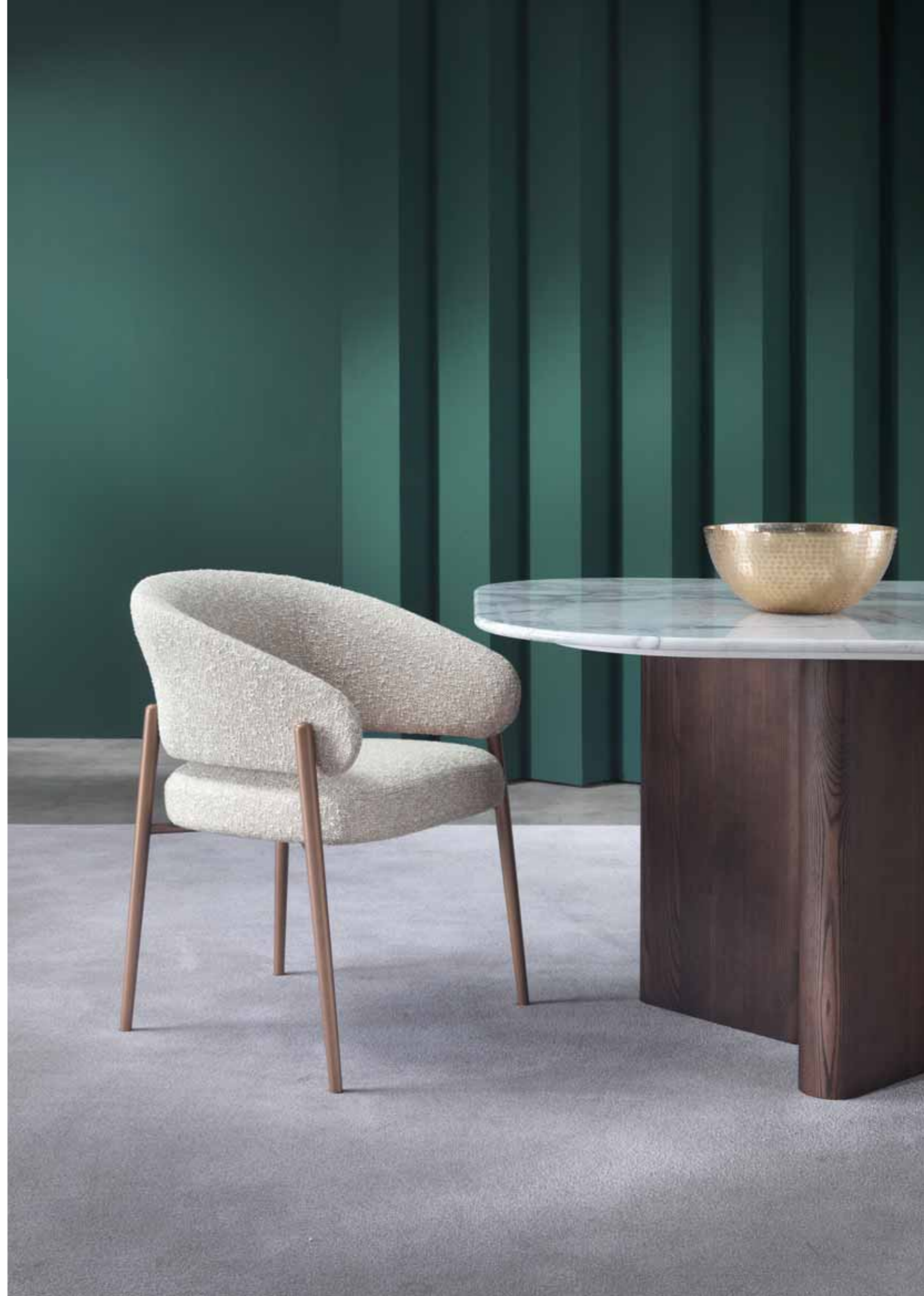



GARY+ANDY composition cm 425x730 made of: 2 x 9GY301 central elements cm 100x100x66h | 2 x 9GY201 side elements cm 130x100x66h | 1 x 9GY303 central element cm 70x100x66h | 1 x 9GY503 backrest cm 100x30x66h | 1 x 9AD105 ottoman cm 125x100x38h | 1 x 9AD101 ottoman cm 100x100x38h | Fabric for GARY elements: cat. H art. Casamance Lierna col. 0327 sable | Leather for ANDY elements: cat. Lusso art. Nabuk col. Talpa C3409 | Cushions: 6 x 9GY103 cm 60x60 | Fabric: cat. H art. Casamance Lierna col. 0327 sable | 2 x 9GY102 cm 45x45 | Leather: cat. Lusso art. Nabuk col. Talpa C3409 | 2 x 9GY102 cm 45x45 | Fabric: cat. F/G art. Misia Aime col. 319 Terre de Sienne | 1 x 9CU106 cm 45x45 | 1 x 9CU103 cm 40x40 | Fabric: cat. H art. Misia La Flèche D'Or col. M 260 701 Seppia

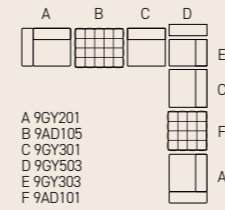

WAVE coffee tables: 7WA104 ø cm 120x27h | 7WA101 ø cm 50x47h | Top: OPP7 Calacatta marble | Base: OPM20 Delabré brass brushed metal | 7WA102 ø cm 60x37h | Top: RAL 3011 Rouge back-painted glass | Base: OPM20 Delabré brass brushed metal **LEAF server tables** 7LE101 cm 64x25x51h OPM16 shiny brass chrome metal **BRERA armchairs** with low backrest 9BRE103 cm 80x82x77h | Fabric: cat. D/E art. Amursk col. 004 | Base: OPM15 antique gold brushed metal **THOR side table** 7TH111 cm 80x80x27h OPP7 Calacatta marble | Base: OPM15 antique gold brushed metal

marelli



GARY+ANDY composition cm 425x730 made of: 2 x 9GY301 central elements cm 100x100x66h | 2 x 9GY201 side elements cm 130x100x66h | 1 x 9GY303 central element cm 70x100x66h | 1 x 9GY503 backrest cm 100x30x66h | 1 x 9AD105 ottoman cm 125x100x38h | 1 x 9AD101 ottoman cm 100x100x38h | Fabric for GARY elements: cat. H art. Casamance Lierna col. 0327 sable | Leather for ANDY elements: cat. Lusso art. Nabuk col. Talpa C3409 **Cushions:** 6 x 9GY103 cm 60x60 | Fabric: cat. H art. Casamance Lierna col. 0327 sable | 2 x 9GY102 cm 45x45 | Leather: cat. Lusso art. Nabuk col. Talpa C3409 | 2 x 9GY102 cm 45x45 | Fabric: cat. F/G art. Misia Aime col. 319 Terre de Sienne | 1 x 9CU106 cm 45x45 | 1 x 9CU103 cm 40x40 | Fabric: cat. H art. Misia La Flèche D'Or col. M 260 701 Seppia **WAVE coffee tables:** 7WA104 ø cm 120x27h | 7WA101 ø cm 50x47h | Top: OPP7 Calacatta marble | Base: OPM20 Delabré brass brushed metal | 7WA102 ø cm 60x37h | Top: RAL 3011 Rouge back-painted glass | Base: OPM20 Delabré brass brushed metal **BRERA armchairs** with low backrest 9BRE103 cm 80x82x77h | Fabric: cat. D/E art. Amursk col. 004 | Base: OPM15 antique gold brushed metal





BRERA armchairs with low backrest 9BRE103 cm 80x82x77h | Fabric: cat. D/E art. Amursk col. 004 | Base: OPM15 antique gold brushed metal **WAVE coffee tables:** 7WA104 ø cm 120x27h | 7WA101 ø cm 50x47h | Top: OPP7 Calacatta marble | Base: OPM20 Delabré brass brushed metal | 7WA102 ø cm 60x37h | Top: RAL 3011 Rouge back-painted glass | Base: OPM20 Delabré brass brushed metal



BRERA armchairs with low backrest 9BRE103 cm 80x82x77h | Fabric: cat. D/E art. Amursk col. 004 | Base: OPM15 antique gold brushed metal **WAVE coffee tables:** 7WA104 ø cm 120x27h | 7WA101 ø cm 50x47h | Top: OPP7 Calacatta marble | Base: OPM20 Delabré brass brushed metal | 7WA102 ø cm 60x37h | Top: RAL 3011 Rouge back-painted glass | Base: OPM20 Delabré brass brushed metal





GARY composition cm 360x100x66h | Fabric: cat. H art. Casamance Lierna col. 0327 sable | Cushions: 3 x 9GY103 cm 60x60 | 2 x 9GY101 cm 40x40 Fabric: cat. H art. Casamance Lierna col. 0327 sable | 2 x 9CU106 cm 45x45 | Fabric: cat. H art. Rubelli Spritz col. 09 oro | 1 x 9CU106 cm 45x45 | Fabric: cat. D/E art. Lucinasco col. 22
WAVE coffee tables 7WA104 ø cm 120x30h | 7WA101 ø cm 50x47h | Top: OPP3 Emperador brown marble | Base: OPM19 Délabré pewter brushed metal **THOR side table** 7TH104 cm 50x50x50h OPP3 Emperador brown marble

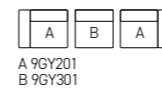

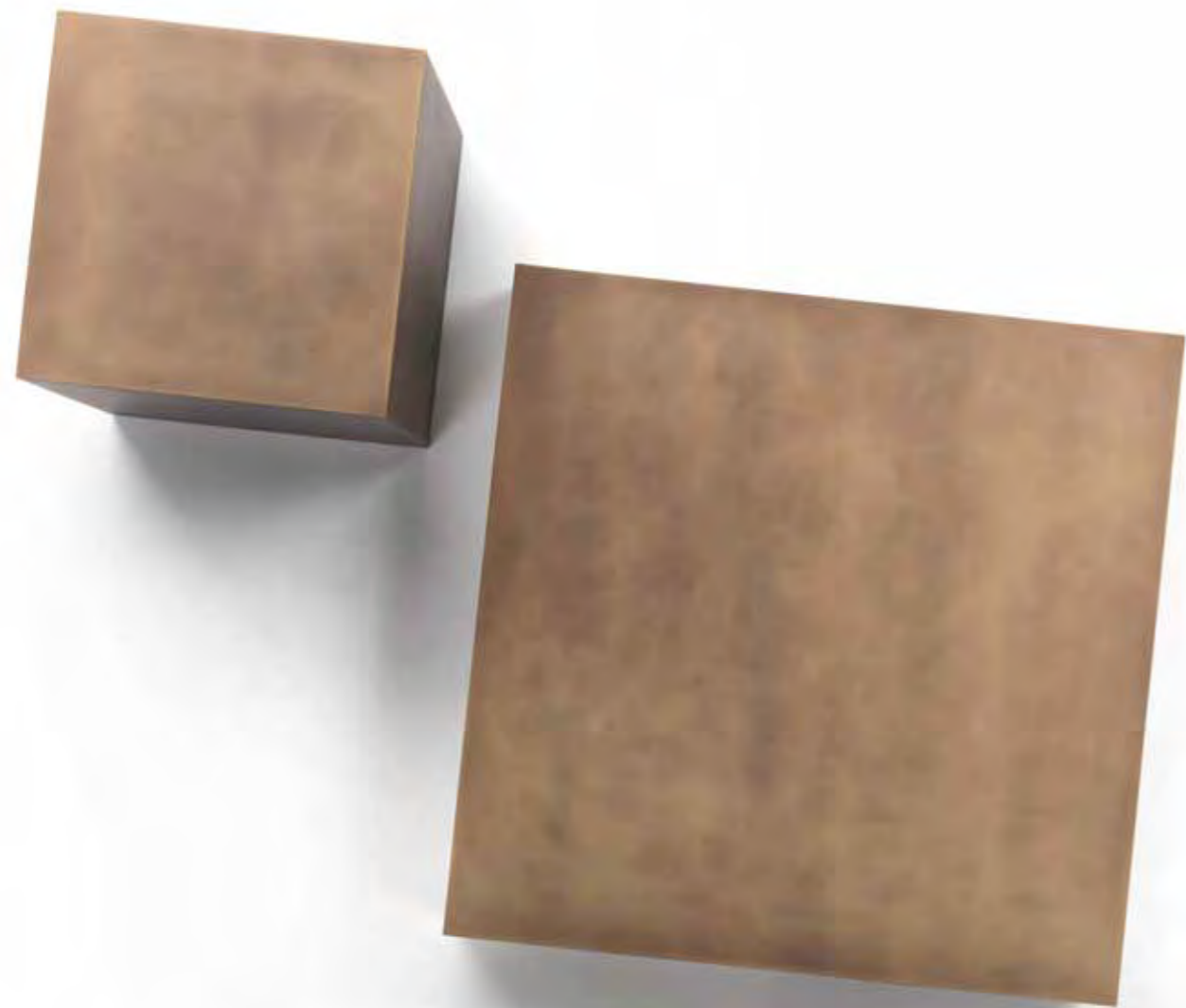

THOR side tables 7TH202 cm 100x100x19h | 7TH204 cm 50x50x50h OPM20 Délabré brass brushed metal
> Detail of **GARY+ANDY composition**





GARY + ANDY composition cm 460x100 made of: 2 x 9GY201 side elements cm 130x100x66h | 1 x 9GY301 central elements cm 100x100x66h | 1 x 9AD101 ottoman cm 100x100x38h | Fabric for GARY elements: cat. H art. Casamance Lierna col. 0327 sable | Leather for ANDY elements: cat. Lusso art. Nabuk col. Talpa C3409 | Cushions: 3 x 9GY103 cm 60x60 | 2 x 9GY101 cm 40x40 | Fabric: cat. H art. Casamance Lierna col. 0327 sable | 1 x 9GY102 cm 45x45 | Leather: cat. Lusso art. Nabuk col. Talpa C3409 | 2 x 9CU106 cm 45x45 | Fabric: cat. H art. Rubelli Spritz col. 25 lichene | 1 x 9CU106 cm 45x45 | 1 x 9CU103 cm 40x40 | Fabric: cat. H art. Misia La Flèche D'Or col. M 260 701 Seppia **LEAF server** 7LE101 cm 64x25x51h OPM16 shiny brass chrome metal **THOR side tables** 7TH102 cm 100x100x19h OPP3 Emperador brown marble **REFLEX Mirror** 7RE106 ø 120x8 Bronze mirror OPM15 antique gold brushed metal frame

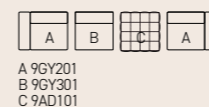

marelli





Detail of decorative cushions



Anderson | Clipper

ANDERSON dining table 7AND101 cm 255x110x71,5h | Base: OPR15 moka matt stained oak | Top: OPP7 Calacatta marble **CLIPPER chairs** 9CLX301 cm 53x62x84h
 | Fabric: cat. F/G art. Casamance Interview 3691 0541 | Base: OPR15 moka matt stained oak

marelli



Detail of **ANDERSON dining table**

< **ANDERSON dining table** 7AND101 cm 255x110x71,5h | Base: OPR15 moka matt stained oak | Top: OPP7 Calacatta marble **CLIPPER chairs** 9CLX301 cm 53x62x84h
| Fabric: cat. F/G art. Casamance Interview 3691 0541 | Base: OPR15 moka matt stained oak





ANDY bespoke composition cm 200x425x325 made of: 2 x elements 9AD200 cm 100x100 | 2 x elements 9AD103 cm 100x100 | 1 x element 9AD115 cm 125x100 | 1 x bespoke element cm 225x100 | Fabric: cat. H art. Dominique Kieffer by Rubelli art. Tweed Décoloré 17270 24 Desert Snow | Base: OPM9 Classic bronze painted metal | Decorative cushions: 6 x 9CU106 cm 45x45 Fabric: cat. F/G art. Misia Aime M188 420 Cuivre | 1 x 9CU106 cm 45x45 | Fabric: Misia Azur Cotonneux M282 204 Mordoré **ATENE coffee tables** 7AT104 ø cm 100x30h | Base: OPM15 antique gold brushed metal | Top: OPP7 Calacatta marble | 7AT111 ø cm 50x40h | Base: OPM15 antique gold brushed metal | Top: OPV9 chrome back-painted bronze glass

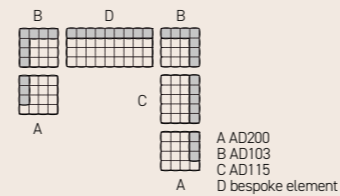

marelli



< **ANDY bespoke composition KYOTO sideboard** 7KY212 cm 220x50x71h | Upper top: OPP7 Calacatta marble | Structure: OPR15 moka matt stained oak | Base: OPM15 antique gold brushed metal

ATENE coffee tables: 7AT104 ø cm 100x30h | Base: OPM15 antique gold brushed metal | Top: OPP7 Calacatta marble | 7AT111 ø cm 50x40h | Base: OPM15 antique gold brushed metal | Top: OPV9 chrome back-painted bronze glass



ANDY bespoke composition cm 200x425x325 made of: 2 x elements 9AD200 cm 100x100 | 2 x elements 9AD103 cm 100x100 | 1 x element 9AD115 cm 125x100 | 1 x bespoke element cm 225x100 | Fabric: cat. H art. Dominique Kieffer by Rubelli art. Tweed Décoloré 17270 24 Desert Snow | Base: OPM9 Classic bronze painted metal | Decorative cushions: 6 x 9CU106 cm 45x45 | Fabric: cat. F/G art. Misia Aime M188 420 Cuivre | 1 x 9CU106 cm 45x45 | Fabric: Misia Azur Cotonneux M282 204 Mordoré **ATENE coffee tables:** 7AT104 ø cm 100x30h | Base: OPM15 antique gold brushed metal | Top: OPP7 Calacatta marble | 7AT111 ø cm 50x40h | Base: OPM15 antique gold brushed metal | Top: OPV9 chrome back-painted bronze glass **KYOTO sideboard** 7KY212 cm 220x50x71h | Upper top: OPP7 Calacatta marble | Structure: OPR15 moka matt stained oak | Base: OPM15 antique gold brushed metal

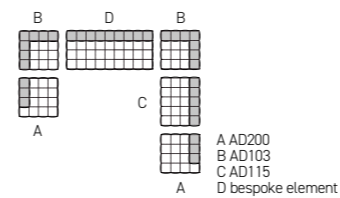



Clipper | Wave | Mike | Nicole

CLIPPER sofa 9CLP203 cm 264x95x90h | Fabric: cat. G art. Casamance Primaute 4092 0820 Bleu Celadon | Base: OPM10 golden beach painted metal | Cushions: 2 x 9CU106 cm 45x45 | Fabric: cat. C art. Koala 122 **CLIPPER low back armchairs** 9CLX107 cm 70x76x75h | Fabric: cat. C art. Koala 122 | Base: OPM10 golden beach painted metal **WAVE coffee tables** 7WA104 ø cm 120x27h | 7WA101 ø cm 50x47h | Top: OPP7 Calacatta marble | Base: OPP20 Délabré brass brushed metal

marelli





WAVE coffee tables 7WA104 ø cm 120x27h | 7WA101 ø cm 50x47h | Top: OPP7 Calacatta marble | Base: OPP20 Délabré brass brushed metal





MIKE dining table 7MK102 cm 240x100x73h | Top: OPP7 Calacatta marble | Base: OPR15 moka matt stained oak **NICOLE chairs** 9NK101 cm 53x56x91h | Fabric: cat.
H art. Sahco Avalon 2 col. 002 | Base: OPR15 moka matt stained oak

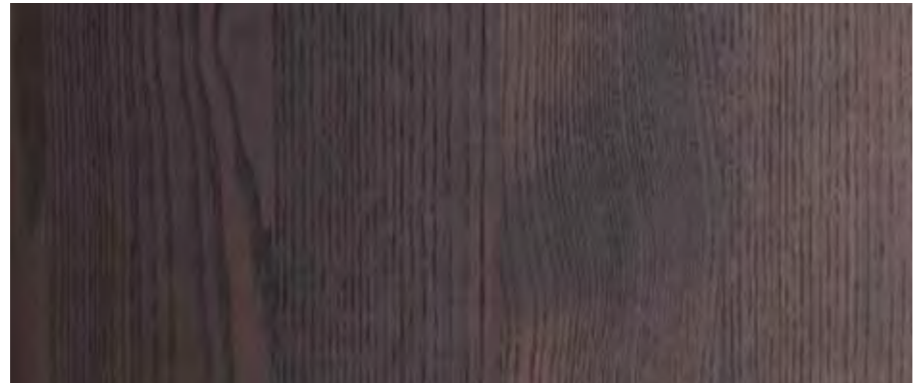

Details of finishes OPP7 Calacatta marble and OPR15 moka matt stained oak.
> **NICOLE chairs** with low backrest 9NK102 cm 53x56x74h | Fabric: cat. H art. Sahco Avalon 2 col. 002 | Base: OPR15 moka matt stained oak



Sign | Kyoto

SIGN swivel armchair 9SI101 cm 83x75x75h | **SIGN sofa** 9SI211 cm 160x75x75h | Leather: cat. Extra art. Soffo col. C50-38 sorgente | Base: OPM18 anodyc bronze painted metal | **KYOTO coffee tables** 7KY101 ø cm 40x48h | 7KY109 ø cm 100x38h | Top: OPP2 Marquinia black marble | Base: OPM16 shiny brass chrome metal

marelli



Details of **SIGN sofa** 9SI211 cm 160x75x75h | Leather: cat. Extra art. Soffio col. C50-38 sorgente | Base: OPM18 anodyc bronze painted metal



SIGN armchair 9SI112 cm 83x75x75h | Fabric: cat. F/G art. Misia Aime M188 622 badiane | Base: OPM16 shiny brass chrome metal.

SIGN swivel armchair 9SI101 cm 83x75x75h **SIGN sofa** 9SI211 cm 160x75x75h | Leather: cat. Extra art. Soffo col. C50-38 sorgente | Base: OPM18 anodyc bronze painted metal **KYOTO coffee tables** 7KY101 ø cm 40x48h | 7KY109 ø cm 100x38h | Top: OPP2 Marquinia black marble | Base: OPM16 shiny brass chrome metal



SIGN armchairs 9SI112 cm 83x75x75h | Fabric: cat. F/G art. Misia Aime M188 622 badiane **SIGN sofa** 9SI211 cm 160x75x75h | Fabric: cat. F/G art. Misia Aime M188 512 bleu turquin | Base: OPM16 shiny brass chrome metal

CHARMING VILLA IN BELLAGIO

*Warm and elegant atmospheres for this magnificent Villa on Lake Como.
The large Living room is dominated by the majestic sofa accompanied by armchairs and tables.
Common feature of all elements are precious materials, fabrics, leather, marbles
and metals in refined finishes and shades.*

ANDY + GARY sofa
BRERA armchairs
THOR table
WAVE coffee tables
MINI server table





*Natural fabrics in warm tones interspersed with precious velvets.
Coffee table tops in refined Calacatta marble and elegant golden finishes.*

CHARMING VILLA IN BELLAGIO

ANDY + GARY sofa
BRERA armchairs
WAVE coffee tables



Warm relaxing tones also for this separate living space, characterized by the round enveloping lines of our Noah sofa in soft natural fabrics and Atene tables.

CHARMING VILLA IN BELLAGIO

- NOAH** sofa and armchairs
- ATENE** coffee tables
- MOON** ottoman
- KYOTO** bespoke sideboard



CHARMING VILLA IN BELLAGIO

NOAH sofa and armchairs
ATENE coffee tables
KYOTO bespoke sideboard

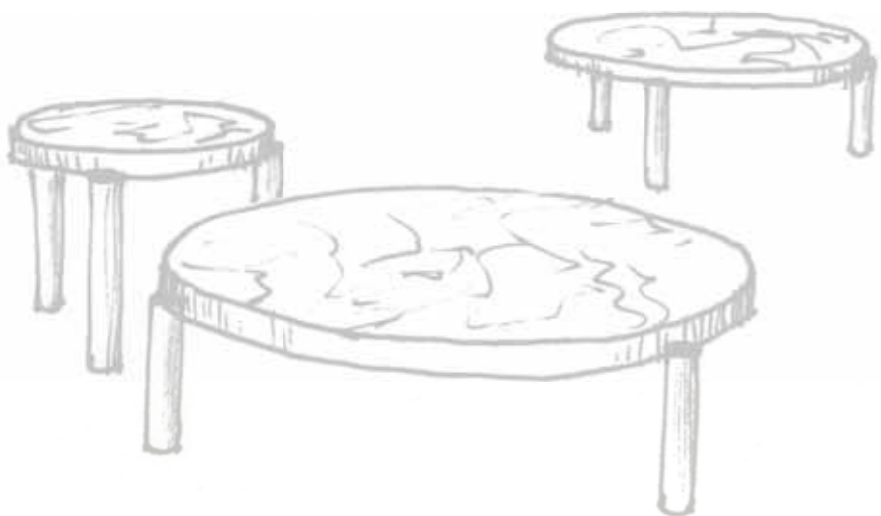

*All the furniture elements are connected by the fil rouge of the project:
contemporary style and timeless elegance.*





*An intimate and refined space for the dining room, that recalls the materials of the other rooms:
table with Calacatta marble top, design chairs
with golden metal base, leather and fabric in natural warm tones.*

BREAK dining table
CHIA chairs
KYOTO sideboard

CHARMING
VILLA IN BELLAGIO



Elegance, light and refined design, the golden shades stand out on the walls, also in the natural materials and tones of stone and wood.

CHARMING VILLA IN BELLAGIO

BREAK dining table
CHIA chairs
LOBEL bookshelf

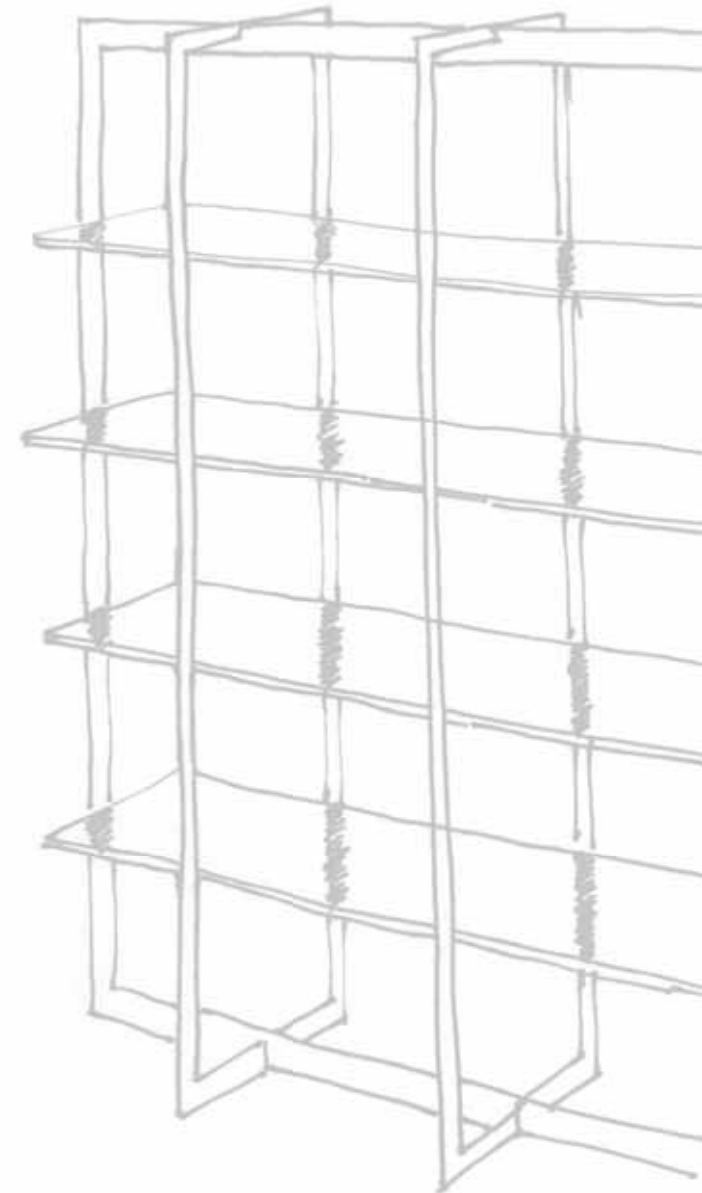



HEBO dining table
 CLIPPER chairs
 KYOTO cupboards
 REFLEX mirror

CHARMING
 VILLA IN BELLAGIO

The search for harmony through the contrast of different materials: white marble that recalls the walls, combined with wood in dark and natural tones and soft fabrics in warm nuances.

CHARMING VILLA IN BELLAGIO

SIGN armchair and sofa
KYOTO coffee tables

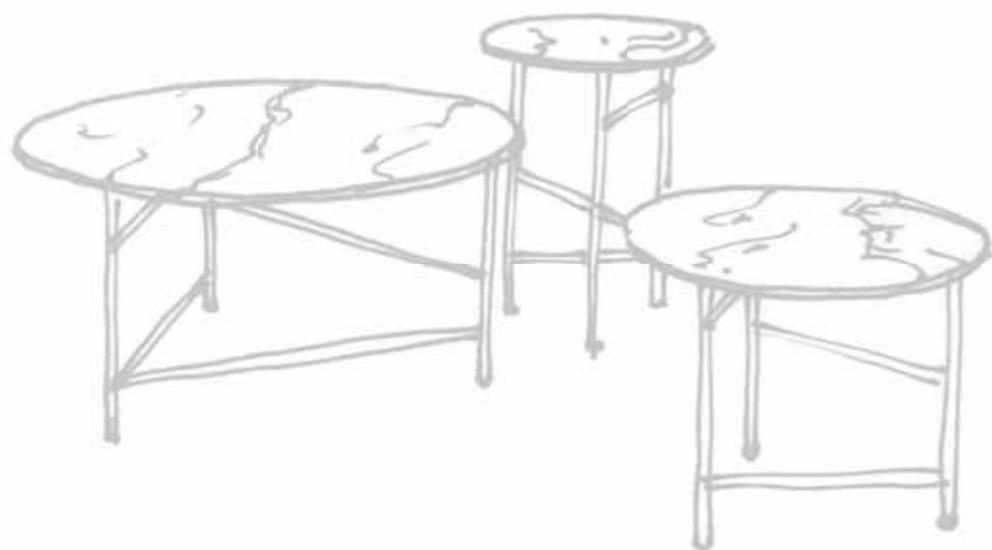

*Nature and warmth outside and inside.
The gentle enveloping lines and the soft velvets of the upholstered elements invite
to relaxation and to an intimate conversation.*





Moon | Sign | Atene

MOON curved sofa 9MN204 cm 305x120x76h | Fabric: cat. H art. Dedar Splendido T15016/29 bois de rose | Base: OPM15 antique gold brushed metal | Cushions: 1 x 9CU106 cm 45x45 | Fabric: cat. H art. Dedar Splendido T15016/29 bois de rose | 1 x 9CU106 cm 45x45 | Fabric: cat. G art. Casamance Primaute 4098 0641 Rose Blush | 2 x 9CU105 cm 50x50 | Fabric: cat. C art. San Diego col. 154 | 1 x 9CU103 cm 40x40 | Fabric: cat. C art. San Diego col. 171 **MOON armchair** 9MN101 cm 98x90x76h | Fabric: cat. H art. Dedar Splendido T15016/29 bois de rose | Base: OPM15 antique gold brushed metal **MOON curved sofa** 9MN203 cm 245x120x76h | Fabric: cat. H art. Sahco Zero col. 008 | Cushions: 1 x 9CU106 cm 45x45 | Fabric: cat. H art. Dedar Splendido T15016/29 bois de rose | 1 x 9CU105 cm 50x50 | Fabric: cat. C art. San Diego col. 154 | 1 x 9CU103 cm 40x40 | Fabric: cat. C art. San Diego col. 171 **ATENE coffee tables** 7AT105 ø cm 120x30h | 7AT101 ø cm 50x50h | Top: OPP21 Calacatta violet marble | Base: OPM16 shiny brass chrome metal





Details of **MOON armchairs** and **sofa** in fabric cat. H art. Dedar Splendido T15016/29 bois de rose

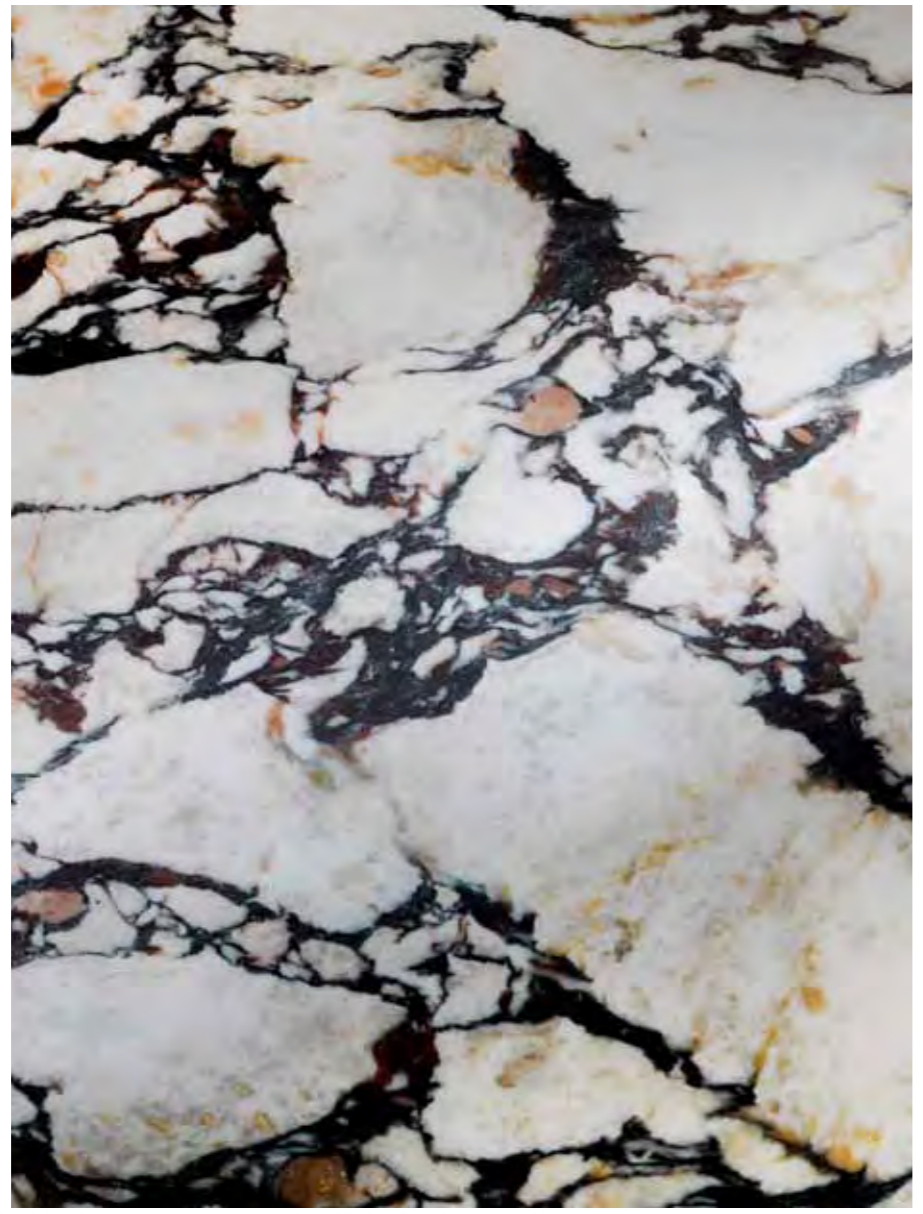

Detail of OPP21 Calacatta violet marble
> **SIGN armchairs** 9S1112 cm 83x75x75h | Fabric: cat. H art. Sahco Zero col. 008 | Base: OPM15 antique gold brushed metal





MOON curved sofa 9MN203 cm 245x120x76h | Fabric: cat. H art. Sahco Zero col. 008 | Cushions: 2 x 9CU106 cm 45x45 | Fabric: cat. H art. Dedar Splendido T15016/29
bois de rose | 1 x 9CU105 cm 50x50 | Fabric: cat. C art. San Diego col. 154 | 1 x 9CU103 cm 40x40 | Fabric: cat. C art. San Diego col. 171



MOON composition cm 336x156 | Fabric: cat. H art. Rubelli Spritz col. 25 lichene | Base: OPM15 antique gold brushed metal | Cushions: 2 x 9CU103 cm 40x40 Fabric: cat. H art. Rubelli Spritz col. 25 lichene | 3 x 9CU105 cm 50x50 | Fabric: cat. H art. Rubelli Spritz col. 05 argilla **MOON armchair** 9MN101 cm 98x90x76h | Fabric: cat. H art. Rubelli Spritz col. 05 argilla | Base: OPM15 antique gold brushed metal **ATENE coffee tables** 7AT105 ø cm 120x30h | 7AT101 ø cm 50x50h | Top: OPP7 Calacatta marble | Base: OPM15 antique gold brushed metal

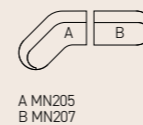

Moon | Atene

marelli



MOON composition cm 336x156 | Fabric: cat. H art. Rubelli Spritz col. 25 lichene | Base: OPM15 antique gold brushed metal | Cushions: 2 x 9CU103 cm 40x40 | Fabric: cat. H art. Rubelli Spritz col. 25 lichene | 3 x 9CU105 cm 50x50 | Fabric: cat. H art. Rubelli Spritz col. 05 argilla **MOON armchair** 9MN101 cm 98x90x76h | Fabric: cat. H art. Rubelli Spritz col. 05 argilla | Base: OPM15 antique gold brushed metal **ATENE coffee tables** 7AT105 ø cm 120x30h | 7AT101 ø cm 50x50h | Top: OPP7 Calacatta marble | Base: OPM15 antique gold brushed metal

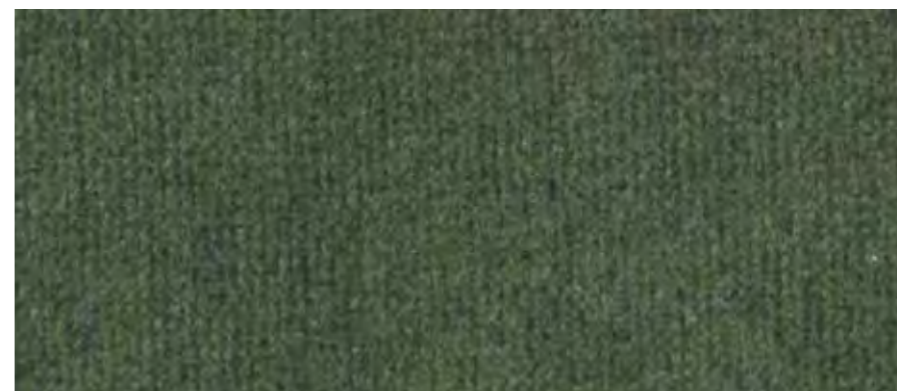

< **ATENE coffee tables** 7AT105 ø cm 120x30h | 7AT101 ø cm 50x50h | Top: OPP7 Calacatta marble | Base: OPM15 antique gold brushed metal
Details of OPP7 Calacatta marble and fabric Rubelli Spritz col. 25 lichene



MOON armchair 9MN101 cm 98x90x76h | Fabric: cat. H art. Rubelli Spritz col. 05 argilla | Base: OPM15 antique gold brushed metal | Cushion: 9CU103 cm 40x40
 | Fabric: cat. H art. Rubelli Spritz col. 25 lichene **ATENE side table** 7AT101 ø cm 50x50h | Top: OPP7 Calacatta marble | Base: OPM15 antique gold brushed metal



Moon | Sign | Wave | Arthur

MOON curved sofa 9MN204 cm 305x120x76h | Leather: cat. Extra art. Lord col. 9210 | Base: OPM11 gold pearl painted metal **SIGN armchairs** 9SI112 cm 83x75x75h
 | Fabric: cat. D/E art. Ostellato col. 20 | Base: OPM15 antique gold brushed metal **WAVE coffee tables** 7WA103 ø cm 100x27h | Top: OPP21 Calacatta violet marble |
 7WA101 ø cm 50x47h | Top: OPP7 Calacatta marble | Base: OPM20 délabré brass brushed metal **ARTHUR side table** 7ART202 ø cm 60x40h | Base: OPM20 délabré
 brass brushed metal | Top: OPP7 Calacatta marble

marelli



Details of **MOON sofa** and **WAVE tables** with marble top



MOON curved sofa 9MN204 cm 305x120x76h | Leather: cat. Extra art. Lord col. 9210 | Base: OPM11 gold pearl painted metal **WAVE coffee tables** 7WA103 ø cm 100x27h | Top: OPP21 Calacatta violet marble | 7WA101 ø cm 50x47h | Top: OPP7 Calacatta marble | Base: OPM20 délabré brass brushed metal **ARTHUR side table** 7ART202 ø cm 60x40h | Base: OPM20 délabré brass brushed metal | Top: OPP7 Calacatta marble.
 > **SIGN armchairs** 9SI112 cm 83x75x75h | Fabric: cat. D/E art. Ostellato col. 20 | Base: OPM15 antique gold brushed metal





Matheus | Brera | Thor | Atene

MATHEUS sofas 9MU206 cm 260x100x88h | Fabric: cat. C art. Koala col. 120 **Extra cushions:** 2 x 9MU101 cm 50x50 with band | Fabric: cat. C art. Koala col. 120 | 1 x 9CU106 cm 45x45 | Fabric: cat. C art. Koala col. 103 **BRERA** armchairs with high back 9BRE106 cm 80x82x101h | Fabric: cat. H art. Rubelli Spritz col. 26 bluetette | Base: OPM9 classic bronze painted metal **ATENE** coffee tables 7AT104 ø cm 100x30h | 7AT101 ø cm 50x40h | Top: OPP20 Arabescato Orobico grey marble | Base: OPM14 shiny black chrome metal **THOR** side table 7TH111 cm 80x80x27h OPP20 Arabescato Orobico grey marble | Base: OPM14 shiny black chrome metal





MATHEUS sofas 9MU206 cm 260x100x88h | Fabric: cat. C art. Koala col. 120 | Extra cushions: 2 x 9MU101 cm 50x50 with band | Fabric: cat. C art. Koala col. 120 | 1 x 9CU106 cm 45x45 | Fabric: cat. C art. Koala col. 103 **BRERA armchairs** with high back 9BRE106 cm 80x82x101h | Fabric: cat. H art. Rubelli Spritz col. 26 bluette | Base: OPM9 classic bronze painted metal **ATENE coffee tables** 7AT104 ø cm 100x30h | 7AT101 ø cm 50x40h | Top: OPP20 Arabescato Orobico grey marble | Base: OPM14 shiny black chrome metal



Detail of OPP20 Arabescato Orobianco grey marble
> **ATENE coffee tables** 7AT104 ø cm 100x30h | 7AT101 ø cm 50x40h | Top: OPP20 Arabescato Orobianco grey marble | Base: OPM14 shiny black chrome metal







Matheus | Twig | Thor | Clip | Leaf

MATHEUS composition cm 340x225 made of : Side element 9MU210 cm 240x100 | Chaise longue 9MU108 cm 225x100 | Ottoman 9MU114 cm 100x100 | Fabric: cat. H art. Sahco Avalon 2 col. 002 | Base: OPM15 antique gold brushed metal | Extra cushions: 2 x 9MU101 cm 50x50 with band Fabric: cat. H art. Sahco Avalon 2 col. 0047 | 3 x 9CU106 cm 45x45 Fabric: cat. H art. Casamance Mollino 4718-0365 Tourterelle **TWIG coffee table** 7TG103 ø cm 100x35h | Top: OPP7 Calacatta gold | Base: OPM15 antique gold brushed metal **THOR side table** 7TH204 cm 50x50x50h OPM20 Délabré brass brushed metal **LEAF server table** 7LE101 cm 64x25x51h OPM16 shiny brass chrome metal **CLIP side table** ø cm 40x50h OPM16 shiny brass chrome metal

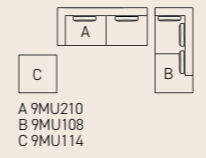

marelli



MATHEUS composition cm 340x225 made of : Side element 9MU210 cm 240x100 | Chaise longue 9MU108 cm 225x100 | Ottoman 9MU114 cm 100x100 | Fabric: cat. H art. Sahco Avalon 2 col. 002 | Base: OPM15 antique gold brushed metal | Extra cushions: 2 x 9MU101 cm 50x50 with band | Fabric: cat. H art. Sahco Avalon 2 col. 0047 | 3 x 9CU106 cm 45x45 | Fabric: cat. H art. Casamance Mollino 4718-0365 Tourterelle **TWIG coffee table** 7TG103 ø cm 100x35h | Top: OPP7 Calacatta gold | Base: OPM15 antique gold brushed metal **THOR side table** 7TH204 cm 50x50x50h OPM20 Délabré brass brushed metal **LEAF server table** 7LE101 cm 64x25x51h OPM16 shiny brass chrome metal

> Detail of **MATHEUS sofa** and **TWIG table** 7TG103 ø cm 100x35h with OPP7 Calacatta marble top and OPM15 antique gold brushed metal base





Lancaster | Thor | Frame

LANCASTER composition cm 305x180 made of: Side element 4LAN214 cm 205x95x85h | Chaise longue 4LAN108 cm 180x100x85h | Fabric: cat. H art. Dedar Belsuede col. 33 | Base: OPM15 antique gold brushed metal | Cushions: 2 x 9VR102 cm 45x45 with band | Fabric: cat. H art. Dedar Belsuede col. 33 | 1 x 9CU106 cm 45x45 | Fabric: cat. F/G art. Misia Aime M188 420 cuivre | 2 x 9CU103 cm 40x40 | Fabric: cat. H art. Casamance Mollino 4718 07 25 **THOR side tables** 7TH101 cm 80x80x19h OPP7 Calacatta marble | 7TH116 cm 60x110x27h OPP7 Calacatta marble OPM13 antique brass brushed metal **FRAME server** 7FR146 cm 55x40x51,5h | Top: OPP7 Calacatta marble | Base: OPM15 antique gold brushed metal

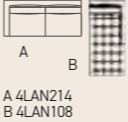



Details of LANCASTER sofa



THOR side tables 7TH101 cm 80x80x19h OPP7 Calacatta marble | 7TH116 cm 60x110x27h OPP7 Calacatta marble OPM13 antique brass brushed metal



LANCASTER composition cm 305x180 made of: Side element 4LAN214 cm 205x95x85h | Chaise longue 4LAN108 cm 180x100x85h | Fabric: cat. H art. Dedar Belsuede col. 33 | Base: OPM15 antique gold brushed metal | Cushions: 2 x 9VR102 cm 45x45 with band Fabric: cat. H art. Dedar Belsuede col. 33 | 1 x 9CU106 cm 45x45 | Fabric: cat. F/G art. Misia Aime M188 420 cuivre | 2 x 9CU103 cm 40x40 | Fabric: cat. H art. Casamance Mollino 4718 07 25 **THOR side tables** 7TH101 cm 80x80x19h OPP7 Calacatta marble | 7TH116 cm 60x110x27h OPP7 Calacatta marble OPM13 antique brass brushed metal **FRAME server** 7FR146 cm 55x40x51,5h | Top: OPP7 Calacatta marble | Base: OPM15 antique gold brushed metal



Richard | Clipper | Frame

RICHARD sofa 9RIC203 cm 271x98x62h | Fabric: cat. F/G art. Orsetto 01/1 | Base: OPM15 antique gold brushed metal | Cushions: 2 x 9RIC102 cm 45x45 with band | Fabric: cat. F/G art. Orsetto 01/1 | 1 x 9CU106 cm 45x45 | Fabric: cat. F/G art. Misia Aime M188 420 cuivre **CLIPPER armchair** 9CLX103 cm 70x80x91h | Fabric: cat. H art. Casamance Manade B4248 1734 Carmin | Base: OPM15 antique gold brushed metal **FRAME coffee table** 7FR122 ø cm 120x28h | Top: OPP11 Grey Stone marble | Base: OPM15 antique gold brushed metal



Detail of **RICHARD** sofa 9RIC203 cm 271x98x62h | Fabric: cat. F/G art. Orsetto 01/1 | Base: OPM15 antique gold brushed metal



RICHARD quilted chaise longue 9RCT215 cm 200x80x62h | Fabric: cat. F/G art. Orsetto 01/1 | Base: OPM18 anodic bronze painted metal **BREAK side table** 7BR101
 ø cm 40x45h | Top: OPP14 Amani bronze marble | Base: OPM17 bronze metal



Richard | Wave

RICHARD sofa 9RIC202 cm 240x98x62h | 2 x cushions 9CU106 cm 45x45 **RICHARD quilted chaise longue** 9RCT215 cm 200x80x62h | 1 x cushion 9CU106 cm 45x45
 | Fabric: cat. F/G art. Misia Aime M188 622 badiane | Base: OPM18 anodyc bronze painted metal **WAVE tables** 7WA103 ø cm 100x27h | 7WA101 ø cm 50x47h | Top: OPP7 Calacatta marble | Base: OPM18 anodyc bronze painted metal

marelli



WAVE tables 7WA104 ø cm 120x27h | 7WA101 ø cm 50x47h | Top: OPP7 Calacatta marble | Base: OPM20 Délabré brass brushed metal | 7WA112 ø cm 60x37h | Top: OPV6 RAL 1019 back-painted glass top | Base: OPM20 Délabré brass brushed metal





RICHARD sofa 9RIC202 cm 240x98x62h | 2 x cushions 9CU106 cm 45x45 **RICHARD quilted chaise longue** 9RCT215 cm 200x80x62h | Fabric: cat. F/G art. Misia Aime M188 622 badiane | Base: OPM18 anodized bronze painted metal **WAVE tables** 7WA103 ø cm 100x27h | 7WA101 ø cm 50x47h | Top: OPP7 Calacatta marble | Base: OPM18 anodized bronze painted metal



Richard | Sign | Wave | Kyoto

RICHARD composition cm 346x248 | Fabric: cat. D/E art. Nebraska 1592/25 | Base: OPM18 anodized bronze painted metal | Cushions: 3 x 9CU106 cm 45x45 | Fabric: cat. D/E art. Nebraska 1592/25 | 1 x 9CU106 cm 45x45 | Fabric: cat. D/E art. Fantasy 1673/16 **SIGN armchairs** 9SI112 cm 83x75x75h | Fabric: cat. D/E art. Fantasy 1673/16 | Base: OPM18 anodized bronze painted metal **WAVE coffee table** 7WA104 ø cm 120x27h | Top: OPP7 Calacatta marble | Base: OPM20 Délabré brass brushed metal **KYOTO cupboard** 7KY209 cm 100x50x125h | Top: OPP7 Calacatta marble | Structure: OPR15 moka matt stained oak | Base: OPM15 antique gold brushed metal

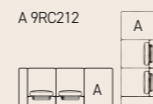

marelli



RICHARD composition cm 346x248 | Fabric: cat. D/E art. Nebraska 1592/25 | Base: OPM18 anodized bronze painted metal | Cushions: 3 x 9CU106 cm 45x45 | Fabric: cat. D/E art. Nebraska 1592/25 | 1 x 9CU106 cm 45x45 | Fabric: cat. D/E art. Fantasy 1673/16 **SIGN armchairs** 9SI112 cm 83x75x75h | Fabric: cat. D/E art. Fantasy 1673/16 | Base: OPM18 anodized bronze painted metal **WAVE coffee table** 7WA104 ø cm 120x27h | Top: OPP7 Calacatta marble | Base: OPM20 Délabré brass brushed metal **KYOTO sideboard** 7KY212 cm 220x50x71h | Top: OPP7 Calacatta marble | Structure: OPR15 moka matt stained oak | Base: OPM15 antique gold brushed metal



Details of finishes OPP7 Calacatta marble and OPM20 D elabr e brass brushed metal



< **SIGN armchairs** 9SI112 cm 83x75x75h | Fabric: cat. D/E art. Fantasy 1673/16 | Base: OPM18 anodyc bronze painted metal



Richard | Clipper | Frame | Clip | Thor

RICHARD composition cm 346x248 | Fabric: cat. D/E art. Fantasy 1673/14 | Base: OPM18 anodyc bronze painted metal | Cushions: 4 x 9CU106 cm 45x45 | Fabric: cat. D/E art. Fantasy 1673/14 | 2 x 9CU106 cm 45x45 | Fabric: cat. F/G art. Misia Aime M188 622 badiane **CLIPPER armchairs** 9CLX105 cm 70x76x75h | Outside: Leather cat. Lusso art. Nabuk C3407 mogano | Inside: Fabric cat. H art. Casamance Manade B4248 4363 **FRAME table** 7FR121 ø cm 100x28h | Top: OPP13 Velvet brown marble | Base: OPM15 antique gold brushed metal **CLIP table** 7CL103 ø cm 40x50h OPM15 antique gold brushed metal **THOR side table** 7TH104 cm 50x50x50h OPP3 Emperador brown marble

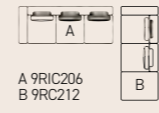

marelli





RICHARD composition cm 346x248 | Fabric: cat. D/E art. Fantasy 1673/14 | Base: OPM18 anodyc bronze painted metal | Cushion: 1 x 9CU106 cm 45x45 | Fabric: cat. F/G art. Misia Aime M188 622 badiane **CLIPPER armchairs** 9CLX105 cm 70x76x75h | Outside: Leather cat. Lusso art. Nabuk C3407 mogano | Inside: Fabric cat. H art. Casamance Manade B4248 4363 **FRAME table** 7FR121 ø cm 100x28h | Top: OPP13 Velvet brown marble | Base: OPM15 antique gold brushed metal **THOR side table** 7TH104 cm 50x50x50h OPP3 Emperador brown marble



RICHARD sofa 9RIC212 cm 248x98x62h | Fabric: cat. D/E art. Fantasy 1673/14 | Cushions: 1 x 9CU106 cm 45x45 | Fabric: cat. D/E art. Fantasy 1673/14 | 1 x 9CU106 cm 45x45 | Fabric: cat. F/G art. Misia Aime M188 622 badiane **FRAME table** 7FR121 ø cm 100x28h | Top: OPP13 Velvet brown marble | Base: OPM15 antique gold brushed metal **CLIP table** 7CL102 ø cm 40x40h OPM15 antique gold brushed metal **THOR side table** 7TH104 cm 50x50x50h OPP3 Emperador brown marble



CLIPPER armchairs 9CLX105 cm 70x76x75h | Outside: Leather cat. Lusso art. Nabuk C3407 mogano | Inside: Fabric cat. H art. Casamance Manade B4248 4363 **THOR**
side table 7TH104 cm 50x50x50h OPP3 Emperador brown marble



Richard | Clipper | Break | Frame

RICHARD quilted sofa 9RCT203 cm 271x98x62h | Leather: cat. Extra art. Sofio C50-05 pietra | Base: OPM18 anodyc bronze painted metal | Cushions: 1 x 9CU106 cm 45x45 | Fabric: cat. H art. Rubelli Spritz col. 25 lichene | 1 x 9CU106 cm 45x45 | Leather: cat. Extra art. Sofio C50-15 Foresta **RICHARD chaise longue** 9RIC213 cm 173x98x62h | Cushion: 1 x 9CU106 cm 45x45 | Leather: cat. Extra art. Sofio C50-05 pietra | Base: OPM18 anodyc bronze painted metal **CLIPPER armchairs** 9CLX107 cm 70x76x75h | Leather: cat. Extra art. Sofio C50-15 Foresta | Base: OPM18 anodyc bronze painted metal **FRAME table** 7FR121 ø cm 100x28h **FRAME server** 7FR127 cm 55x27x51,5h **BREAK table** 7BR101 ø cm 40x50h | Top: OPP14 Amani bronze marble | Base: OPM17 bronze metal

marelli



Details of **RICHARD** sofa and **chaise longue** in leather cat. Extra art. Sofio C50-05 pietra and **FRAME** tables with OPP14 Amani bronze marble top



Details of **RICHARD** quilted sofa in leather cat. Extra art. Soffio C50-05 pietra





RICHARD quilted sofa 9RCT203 cm 271x98x62h | Leather: cat. Extra art. Soffio C50-05 pietra | Base: OPM18 anodyc bronze painted metal | Cushions: 2 x 9CU106 cm 45x45 | Leather: cat. Extra art. Soffio C50-15 Foresta **RICHARD chaise longue** 9RIC213 cm 173x98x62h | Cushion: 1 x 9CU106 cm 45x45 | Leather: cat. Extra art. Soffio C50-05 pietra | Base: OPM18 anodyc bronze painted metal **CLIPPER armchairs** 9CLX107 cm 70x76x75h | Leather: cat. Extra art. Soffio C50-15 Foresta | Base: OPM18 anodyc bronze painted metal **FRAME table** 7FR121 ø cm 100x28h **BREAK table** 7BR101 ø cm 40x50h | Top: OPP14 Amani bronze marble | Base: OPM17 bronze metal



Ritz | Wave | Mini | Kyoto | Mini

RITZ composition cm 402 | Outside: Leather cat. Extra art. Soffio 50-65 | Inside: Fabric cat. D/E art. Ostellato col. 06 | Base: OPM15 antique gold brushed metal | Cushions: 2 x 9CU106 cm 45x45 | 3 x 9CU103 cm 40x40 | Fabric: cat. D/E art. Ostellato col. 06 | x 9CU106 cm 45x45 | Fabric: cat. H art. Rubelli Spritz col. 25 lichene | 2 x 9CU106 cm 45x45 | Leather: cat. Extra art. Soffio 50-65 **CLIPPER swivel armchair** with low back 9CLX108 cm 70x76x75h | Leather: cat. Extra art. Soffio 50 15 | Base: OPM16 shiny brass chrome metal **WAVE tables** 7WA103 ø cm 100x27h | 7WA101 ø cm 50x47h | Top: OPP20 Arabescato Orobito grey marble | Base: OPM19 Délabré Pewter brushed metal

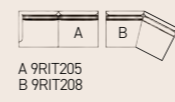

marelli



RITZ composition cm 402 | Outside: Leather cat. Extra art. Sofio 50-65 | Inside: Fabric cat. D/E art. Ostellato col. 06 | Base: OPM15 antique gold brushed metal | Cushions: 2 x 9CU106 cm 45x45 | 3 x 9CU103 cm 40x40 | Fabric: cat. D/E art. Ostellato col. 06 | 1 x 9CU106 cm 45x45 | Fabric: cat. H art. Rubelli Spritz col. 25 lichene | 2 x 9CU106 cm 45x45 | Leather: cat. Extra art. Sofio 50-65 **CLIPPER swivel armchair** with low back 9CLX108 cm 70x76x75h | Leather: cat. Extra art. Sofio 50 15 | Base: OPM16 shiny brass chrome metal **WAVE tables** 7WA103 ø cm 100x27h | 7WA101 ø cm 50x47h | Top: OPP20 Arabescato Orobico grey marble | Base: OPM19 Délabré Pewter brushed metal **MINI server table** 9TX160 cm 25x40x50h OPM15 antique gold brushed metal



Detail of backrest of **RITZ** sofa



CLIPPER swivel armchairs with low back 9CLX108 cm 70x76x75h | Leather: cat. Extra art. Sofio 50 15 | Base: OPM16 shiny brass chrome metal **WAVE side table** 7WA101 ø cm 50x47h | Top: OPP20 Arabescato Orobico grey marble | Base: OPM19 Délabré Pewter brushed metal **KYOTO cupboards** 7KY209 cm 100x50x125h | Top: OPP7 Calacatta marble | Structure: OPR15 moka matt stained oak | Base: OPM15 antique gold brushed metal



Ritz | Clip | Twig | Arthur

RITZ sofa 9RIT203 cm 275x95x86h | Outside: Leather cat. Lusso art. Nabuk C/3407 mogano | Inside: Fabric cat. F/G art. Aime Misia M188 420 cuivre | Base: OPM17 bronze metal | Cushions: 3 x 9CU106 cm 45x45 | Fabric cat. F/G art. Aime Misia M188 420 cuivre | 1 x CU106 cm 45x45 | Leather: cat. Lusso art. Nabuk Seppia **TWIG coffee table** 7TG103 ø 100x35h | Top: OPP13 Velvet brown marble | Base: OPM17 bronze metal **CLIP side tables** 7CL102 ø cm 40x40h | 7CL103 ø cm 40x50h OPM17 bronze metal

marelli



RITZ armchairs 9RIT101 cm 85x95x86h | Outside: Leather cat. Lusso art. Nabuk C/3407 mogano | Inside: Fabric cat. F/G art. Aime Misia M188 420 cuivre | Base: OPM17 bronze metal | Cushion: 9CU106 cm 45x45 | Fabric cat. F/G art. Aime Misia M188 420 cuivre **CLIP side tables** 7CL102 ø cm 40x40h | 7CL103 ø cm 40x50h OPM17 bronze metal



< **RITZ sofa** 9RIT203 cm 275x95x86h | Outside: Leather cat. Lusso art. Nabuk C/3407 mogano | Inside: Fabric cat. F/G art. Aime Misia M188 420 cuivre | Base: OPM17 bronze metal
TWIG coffee table 7TG103 ø 100x35h | Top: OPP13 Velvet brown marble | Base: OPM17 bronze metal **CLIP side table** 7CL103 ø cm 40x50h OPM17 bronze metal



RITZ sofa 9RIT203 cm 275x95x86h **RITZ armchairs** 9RIT101 cm 85x95x86h | Outside: Leather cat. Lusso art. Nabuk C/3407 mogano | Inside: Fabric cat. F/G art. Aime Misa M188 420 cuivre | Base: OPM17 bronze metal **TWIG coffee table** 7TG103 ø 100x35h | Top: OPP13 Velvet brown marble | Base: OPM17 bronze metal **CLIP side tables** 7CL102 ø cm 40x40h | 7CL103 ø cm 40x50h OPM17 bronze metal



RITZ composition cm 318x152 | Outside: Leather cat. Extra art. Manhattan col. 2172 | Inside: Fabric cat. D/E art. Jurga 02 | Base: OPM15 antique gold brushed metal
 | Cushions: 3 x 9CU106 cm 45x45 | Leather cat. Extra art. Manhattan col. 2172 **ARTHUR tables** 7ART203 ø cm 120x30h | 7ART202 ø cm 60x40h | Top: OPP7 Calacatta marble | Base: OPM20 Délabé brass brushed metal

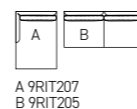



Moon | Arthur

MOON curved sofas 9MN204 cm 305x120x76h | Fabric: cat. F/G art. Misia Aime M188 705 Mordoré | Base: OPM13 antique brass brushed metal | Cushions: 1 x 9CU106 cm 45x45 | Fabric: cat. F/G art. Misia Aime M188 631 Terre d'ombre | 1 x 9CU106 cm 45x45 | Fabric: cat. D/E art. Lucinasco col. 22 **ARTHUR table** 7ART213 ø cm 120x30h | Top: OPV4 RAL 9017 traffic black back-painted glass | Base: OPM20 Délabré brass brushed metal



MOON curved sofas 9MN204 cm 305x120x76h | Fabric: cat. F/G art. Misia Aime M188 705 Mordoré | Base: OPM13 antique brass brushed metal | Cushions: 1 x 9CU106 cm 45x45 | Fabric: cat. F/G art. Misia Aime M188 631 Terre d'ombre | 1 x 9CU106 cm 45x45 | Fabric: cat. D/E art. Lucinasco col. 22



ARTHUR table 7ART213 ø cm 120x30h | Top: OPV4 RAL 9017 traffic black back-painted glass | Base: OPM20 Délabré brass brushed metal



MOON curved sofa 9MN203 cm 245x120x76h | Fabric: cat. F/G art. Misia Aime M188 824 Vieux Rose | Base: OPM10 golden beach painted metal | Cushions: 2 x 9CU106 cm 45x45 | Fabric: cat. F/G art. Misia Aime M188 631 Terre d'ombre **MOON ottoman** 9MN102 ø 60x40h | Fabric: cat. F/G art. Misia Aime M188 631 Terre d'ombre | Base: OPM10 golden beach painted metal **MOON ottoman** 9MN102 ø cm 60x40h | Fabric: cat. H art. Casamance Montalambert 4100 0662 jaune or | Base: OPM15 antique gold brushed metal **MOON ottoman** 9MN102 ø cm 60x40h | Fabric: cat. H art. Misia Azur Cotonneux M282 103 ivoire **CLIP coffee table** 7CL103 ø cm 40x50h OPM10 golden beach painted metal



MOON ottoman 9MN102 ø 60x40h | Fabric: cat. F/G art. Misia Aime M188 631 Terre d'ombre | Base: OPM10 golden beach painted metal **MOON ottoman** 9MN102 ø cm 60x40h | Fabric: cat. H art. Casamance Montalambert 4100 0662 jaune or | Base: OPM15 antique gold brushed metal **MOON ottoman** 9MN102 ø cm 60x40h | Fabric: cat. H art. Misia Azur Cotonneux M282 103 ivoire **CLIP coffee table** 7CL103 ø cm 40x50h OPM10 golden beach painted metal < **MOON curved sofa** 9MN203 cm 245x120x76h | Fabric: cat. F/G art. Misia Aime M188 824 Vieux Rose | Base: OPM10 golden beach painted metal | Cushions: 2 x 9CU106 cm 45x45 | Fabric: cat. F/G art. Misia Aime M188 631 Terre d'ombre **CLIP coffee table** 7CL103 ø cm 40x50h OPM10 golden beach painted metal





*Modern and minimal style for this exclusive penthouse in Miami.
In the centre of the kitchen, the Wave dining table with Chia chairs, characterized
by neutral tones and finishes, common feature of all the kitchen elements.*

WAVE dining table
CHIA chairs
REFLEX mirror

EXCLUSIVE
PENTHOUSE IN MIAMI

EXCLUSIVE
PENTHOUSE IN MIAMI

ONNO dining table
LINDA chairs

*The space for conviviality is also characterized by neutral tones and finishes.
Contrasts of dark and light colours both in the Onno table, with the warm Calacatta marble top
and the moka matt wooden base,
and in the Linda chairs, with the precious light fabric cover and the dark metal legs.*

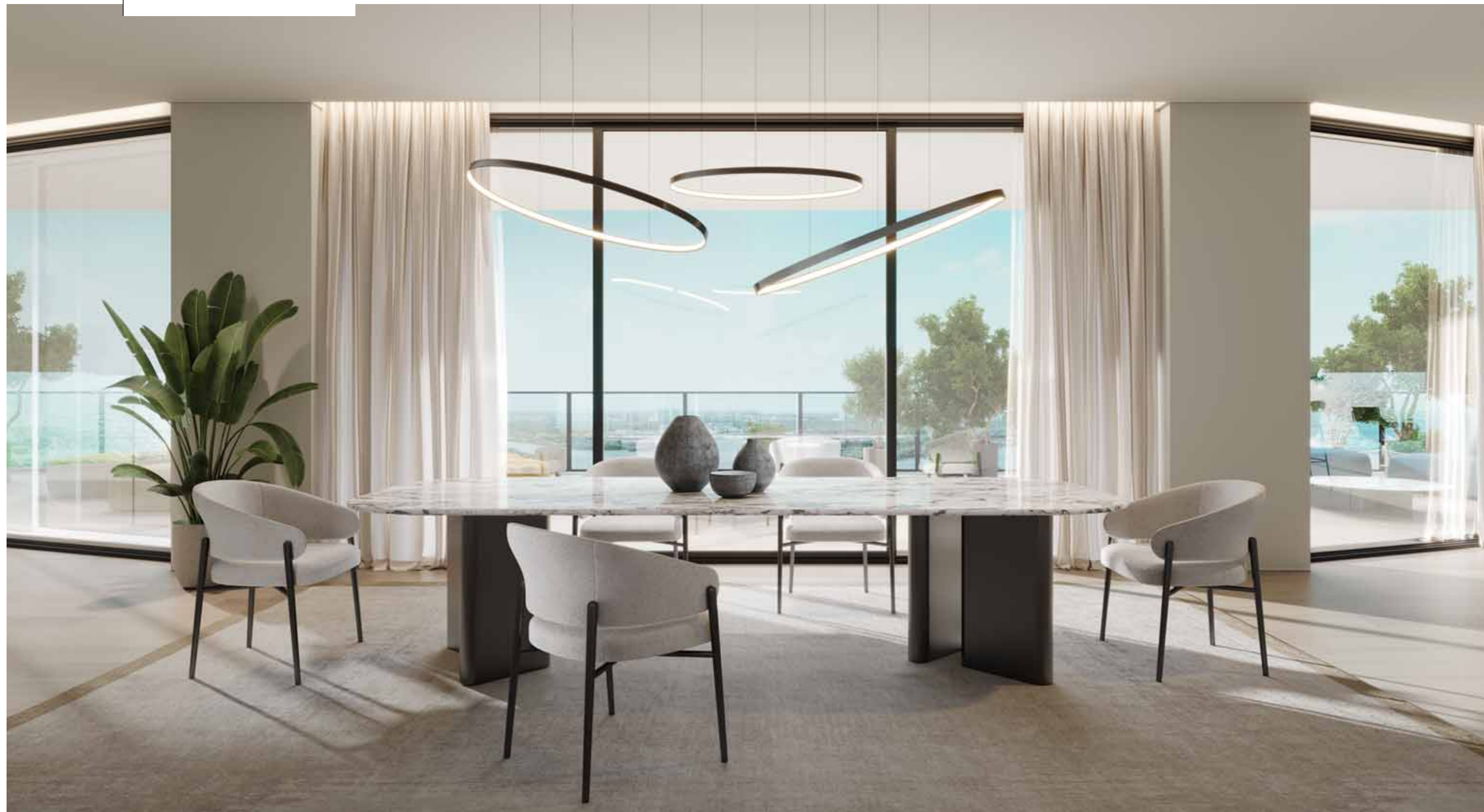



*The living room is a space for relaxation and conversation.
The neutral tones that connect all the rooms and which characterize sofa and table tops,
are here enriched by the blue tones of the armchairs and decorative cushions,
creating a sense of continuity with the surrounding landscape.*

MATHEUS sofa
BRERA armchairs
KYOTO coffee tables
THOR side table
KYOTO cupboard

EXCLUSIVE
PENTHOUSE IN MIAMI



ATACAMA sofas
WAVE coffee tables

EXCLUSIVE
 PENTHOUSE IN MIAMI

The space outside on the terrace is a natural continuation of the inside and of the surrounding landscape: blue and neutral tones. After lunch or dinner, it is possible to sit outside and enjoy conversation in this peaceful private space.

*Fabrics and finishes in warm tones for our sofas and tables,
which invite to enjoy the space and conversation outside on the terrace.*

EXCLUSIVE PENTHOUSE IN MIAMI

ATACAMA sofas
SAHARA sofas
WAVE coffee tables

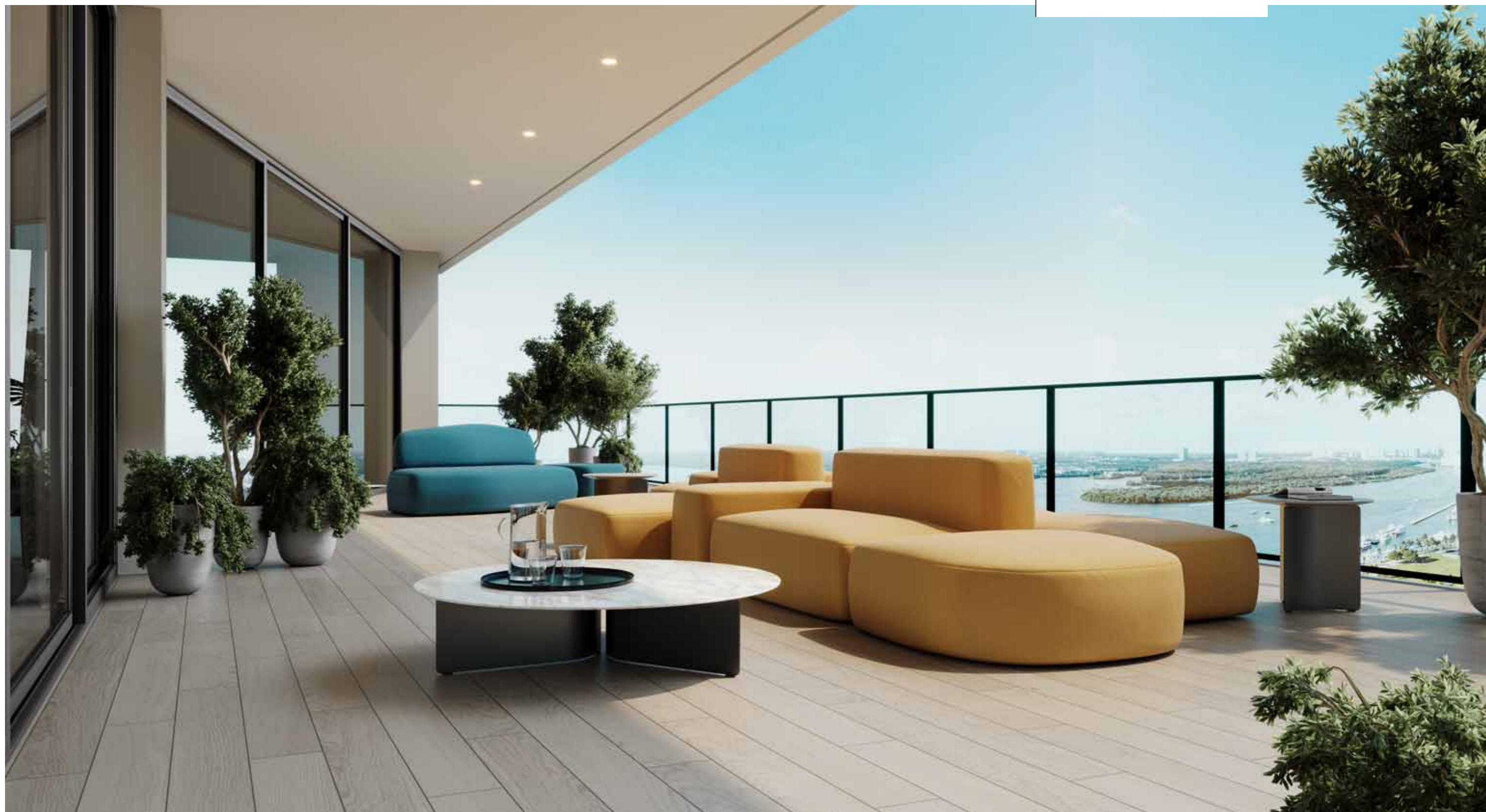



*A space for private meetings or relaxation outside,
with the Joy swivel armchairs and the Break table. Curved lines and essential style.*

EXCLUSIVE
PENTHOUSE
IN MIAMI

BREAK dining table
JOY armchairs



EXCLUSIVE PENTHOUSE IN MIAMI

DEXTER bed
WAVE side tables
SIGN armchairs
CLIP side tables
MOON customized bench
REFLEX mirror

*The bedroom is also connected to the other rooms by the warm neutral tones of the fabrics, metal and marble finishes.
The upholstered bed with enveloping headboard guarantees quiet and relaxation, but there is also a space dedicated to reading or conversation on the Sign armchairs.*



Colori e finiture

COLOURS AND FINISHES

Finiture metallo

METAL FINISHES

Finiture metallo

METAL FINISHES



260

LIFESTYLE COLLECTION N.2 _ MARELLI

OPM1 Metallo cromo lucido <i>Shiny chrome metal</i> Metall glänzend verchromt Métal chromé brillant		OPM7 Metallo verniciato RAL 9016 bianco <i>RAL 9016 white painted metal</i> Metall RAL 9016 weiss lackiert Métal laqué blanc RAL 9016	
OPM2 Metallo spazzolato cromo satinato <i>Brushed matt chrome metal</i> Metall matt verchromt (gebürstet) Métal chromé mat (brossé)		OPM9 Metallo verniciato classic bronze <i>Classic bronze painted metal</i> Metall classic bronze lackiert Métal laqué classic bronze	
OPM3 Metallo spazzolato canna di fucile <i>Brushed matt dark grey metal</i> Metall dunkelgrau gebürstet Métal brossé canon de fusil		OPM10 Metallo verniciato golden beach <i>Golden beach painted metal</i> Metall golden beach lackiert Métal laqué golden beach	
OPM6 Metallo verniciato RAL 9017 nero <i>RAL 9017 black painted metal</i> Metall RAL 9017 schwarz lackiert Métal laqué noir RAL 9017			

261

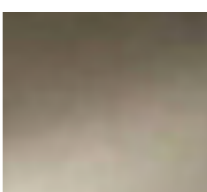
LIFESTYLE COLLECTION N.2 _ MARELLI

OPM11 Metallo verniciato gold pearl <i>Gold pearl painted metal</i> Metall gold pearl lackiert Métal laqué gold pearl		OPM18 Metallo verniciato anodyc bronze <i>Anodyc bronze painted metal</i> Métal laqué anodyc bronze Metall Anodyc Bronze lackiert	
OPM12 Metallo spazzolato rame <i>Brushed copper metal</i> Metall Kupfer gebürstet Métal brossé cuivre		OPM19 Metallo spazzolato peltro Délabré <i>Délabré pewter brushed metal</i> Metall Zinn délabré gebürstet Métal brossé étain délabré	
OPM13 Metallo spazzolato ottone antico <i>Brushed antique brass metal</i> Metall Antik Messing gebürstet Métal brossé laiton antique		OPM20 Metallo spazzolato ottone Délabré <i>Délabré brass brushed metal</i> Metall Messing délabré gebürstet Métal brossé laiton délabré	
OPM14 Metallo cromo nero lucido <i>Shiny black chrome metal</i> Metall schwarz glänzend verchromt Métal chromé noir brillant		OPM21 Metallo verniciato bronzo scuro <i>Dark bronze painted metal</i> Metall dunkelbronze lackiert Métal laqué bronze foncé	
OPM15 Metallo spazzolato oro antico <i>Brushed antique gold metal</i> Metall Antik gold gebürstet Métal brossé or antique		OPM22 Metallo verniciato Prosecco <i>Prosecco painted metal</i> Metall Prosecco lackiert Métal laqué Prosecco	
OPM16 Metallo cromo ottone lucido <i>Shiny brass chrome metal</i> Metall Messing glänzend verchromt Métal chromé laiton brillant		OPM23 Metallo verniciato Tabacco <i>Tobacco painted metal</i> Metall Tabak lackiert Métal laqué tabac	
OPM17 Metallo bronzo <i>Bronze metal</i> Metall Bronze Métal bronze			

Finiture rovere









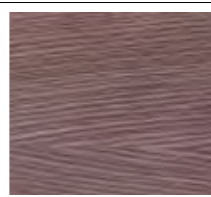

OAK FINISHES

Finiture vetro

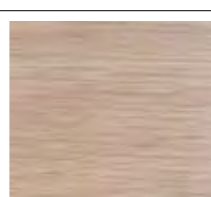
GLASS FINISHES



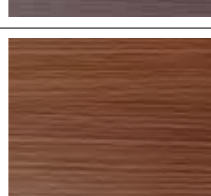

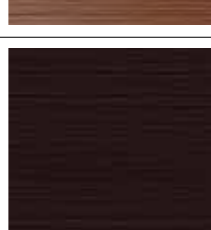

262

LIFESTYLE COLLECTION N.2 _ MARELLI

<p>OPR1 Rovere tinto ciliegio <i>Cherry stained oak</i> <i>Eiche Kirschbaum gebeizt</i> <i>Chêne teinté merisier</i></p>		<p>OPR8 Rovere tinto tabacco <i>Tobacco stained oak</i> <i>Eiche tabak gebeizt</i> <i>Chêne teinté tabac</i></p>	
<p>OPR2 Rovere tinto wengé <i>Wengé stained oak</i> <i>Eiche Wenge gebeizt</i> <i>Chêne teinté wengé</i></p>		<p>OPR9 Rovere tinto grigio tortora <i>Grey taupe stained oak</i> <i>Eiche beige-grau gebeizt</i> <i>Chêne teinté taupe</i></p>	
<p>OPR3 Rovere tinto noce <i>Walnut stained oak</i> <i>Eiche Nussbaum gebeizt</i> <i>Chêne teinté noyer</i></p>		<p>OPR10 Rovere sbiancato <i>Whitened oak</i> <i>Eiche gebleicht</i> <i>Chêne blanchi</i></p>	
<p>OPR4 Rovere tinto naturale <i>Natural oak</i> <i>Eiche natur farblos lackiert</i> <i>Chêne naturel</i></p>		<p>OPR11 Rovere tinto antracite <i>Charcoal stained oak</i> <i>Eiche Anthrazit gebeizt</i> <i>Chêne teinté anthracite</i></p>	
<p>OPR5 Rovere tinto nero <i>Black stained oak</i> <i>Eiche schwarz gebeizt</i> <i>Chêne teinté noir</i></p>		<p>OPR12 Rovere tinto mogano <i>Mahogany stained oak</i> <i>Eiche mahagonifarbig gebeizt</i> <i>Chêne teinté acajou</i></p>	
<p>OPR6 Rovere tinto ciliegio Milano <i>Cherry Milano stained oak</i> <i>Eiche Kirschbaum Milano gebeizt</i> <i>Chêne teinté merisier Milano</i></p>		<p>OPR15 Rovere tinto moka opaco <i>Moka matt stained oak</i> <i>Eiche moka matt gebeizt</i> <i>Chêne teinté moka mat</i></p>	

263

LIFESTYLE COLLECTION N.2 _ MARELLI

<p>OPV1 Vetro trasparente <i>Transparent glass</i> <i>Klarglas</i> <i>Verre transparent</i></p>		<p>OPV7 Vetro retroverniciato nei colori RAL Classic <i>Glass back-painted in the RAL Classic colours</i> <i>Von hinten lackiertes Glas in den RAL Classic Farben</i> <i>Verre laqué de dessous dans les couleurs RAL Classic</i></p>	<p>Colori RAL standard RAL standard colours</p>
<p>OPV2 Vetro satinato <i>Frosted glass</i> <i>Mattglas</i> <i>Verre dépoli</i></p>		<p>OPV9 Vetro bronzato retroverniciato cromo <i>Chrome back-painted bronze glass</i> <i>Von hinten chromlackiertes Bronzenglas</i> <i>Verre bronzé laqué de dessous chrome</i></p>	
<p>OPV3 Vetro retroverniciato RAL 9016 bianco traffico <i>RAL 9016 traffic white back-painted glass</i> <i>RAL 9016 verkehrsweiß von hinten lackiertes Glas</i> <i>Verre laqué de dessous RAL 9016 blanc signalisation</i></p>		<p>OPV10 Vetro grigio retroverniciato cromo <i>Chrome back-painted grey glass</i> <i>Von hinten chromlackiertes Grauglas</i> <i>Verre gris laqué de dessous chrome</i></p>	
<p>OPV4 Vetro retroverniciato RAL 9017 nero traffico <i>RAL 9017 traffic black back-painted glass</i> <i>RAL 9017 verkehrsschwarz von hinten lackiertes Glas</i> <i>Verre laqué de dessous RAL 9017 noir signalisation</i></p>		<p>OPV12 Vetro bronzato trasparente <i>Transparent bronze glass</i> <i>Klarglas bronze</i> <i>Verre transparent bronzé</i></p>	
<p>OPV5 Vetro retroverniciato RAL 7044 grigio seta <i>RAL 7044 silk grey back-painted glass</i> <i>RAL 7044 seidengrau von hinten lackiertes Glas</i> <i>Verre laqué de dessous RAL 7044 gris soie</i></p>		<p>OPV13 Vetro grigio trasparente <i>Transparent grey glass</i> <i>Klarglas grau</i> <i>Verre transparent gris</i></p>	
<p>OPV6 Vetro retroverniciato RAL 1019 beige grigiastro <i>RAL 1019 grey beige back-painted glass</i> <i>RAL 1019 graubeige von hinten lackiertes Glas</i> <i>Verre laqué de dessous RAL 1019 beige gris</i></p>			

Finiture marmi

MARBLES FINISHES

264

LIFESTYLE COLLECTION N.2 _ MARELLI

OPP1

Marmo Carrara bianco
Carrara white marble
Marmor Carrara weiss
Marbre blanc Carrara



OPP14

Marmo Amani Bronze
Amani Bronze marble
Marmor Amani Bronze
Marbre Amani Bronze



OPP2

Marmo nero Marquinia
Marquinia black marble
Marmor Marquinia schwarz
Marbre noir Marquinia



OPP15

Marmo Bianco Covelano
Covelano white marble
Marmor Covelano weiss
Marbre blanc Covelano



OPP3

Marmo Emperador marrone
Emperador brown marble
Marmor Emperador braun
Marbre brun Emperador



OPP16

Marmo Sahara nero
Sahara noir marble
Marmor Sahara noir
Marbre Sahara noir



OPP7

Marmo Calacatta oro
Calacatta gold marble
Marmor Calacatta gold
Marbre Calacatta or



OPP17

Marmo Port Laurent
Port Laurent marble
Marmor Port Laurent
Marbre Port Laurent



OPP9

Marmo Black and gold
Black and gold marble
Marmor Black and gold
Marbre Black and gold

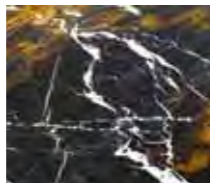

OPP18

Marmo Arabescato Vagli
Arabescato Vagli marble
Marmor Arabescato Vagli
Marbre Arabescato Vagli

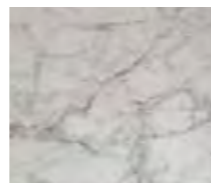

OPP10

Marmo Perfetto brown
Perfetto brown marble
Marmor Perfetto braun
Marbre brun Perfetto



OPP19

Marmo Calacatta Vagli
Calacatta Vagli marble
Marmor Calacatta Vagli
Marbre Calacatta Vagli

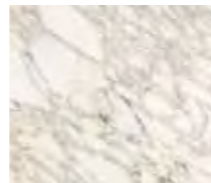

OPP11

Marmo Grey Stone
Grey Stone marble
Marmor Grey Stone
Marbre Grey Stone

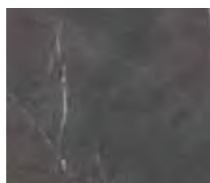

OPP20

Marmo Arabescato grigio orobico
Arabescato orobico grey marble
Marmor arabescato orobico grau
Marbre arabescato orobico gris



OPP12

Marmo Verde Guatemala
Guatemala green marble
Marmor Guatemala grün
Marbre vert Guatemala



OPP21

Marmo Calacatta viola
Calacatta violet marble
Marmor Calacatta violett
Marbre Calacatta violett



OPP13

Marmo Velvet brown
Velvet brown marble
Marmor Velvet brown
Marbre Velvet brown



Finiture pietre

STONES FINISHES

Finiture gres porcellanato effetto marmo

PORCELAIN STONEWARE MARBLE EFFECT FINISHES

265

LIFESTYLE COLLECTION N.2 _ MARELLI

OPP4

Pietra Serena grigia
Grey Serena stone
Grauer Serena Stein
Pierre grise Serena



OPG2 Nero Marquinia



OPP5

Pietra di Brera beige
Beige Brera stone
Beige Brera Stein
Pierre beige Brera

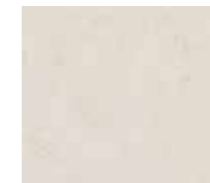

OPG3 Statuario Select

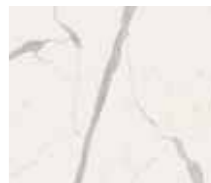

OPG4 Calacatta Royal

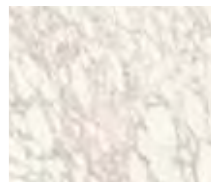

Schede tecniche

TECHNICAL INFORMATION

Tavoli
Tables

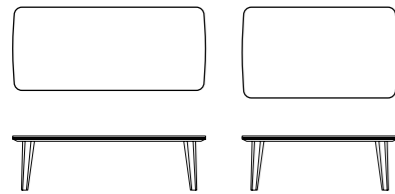

7AND101
Top in marmo / Marble top
Base in legno / Wooden base
L255 P110 H71,5

7AND103
Top in marmo / Marble top
Base in legno / Wooden base
L205 P100 H71,5

Top: Gres Porcellanato, spessore 12 mm
Top: Porcelain Stoneware, 12 mm thick

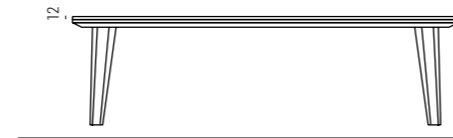

Top: marmo, spessore 20 mm
Top: marble, 20 mm thick



Caratteristica del modello è la tipica lavorazione a "trapuntatura" fatta a mano. Struttura: legno massello e pannelli multistrato rivestiti in poliuretano espanso e dacron. Seduta: imbottitura in poliuretano espanso a quote differenziate di 30 e 40 kg/mc, rivestita con fibre termolegate. Schienale: imbottitura in poliuretano espanso a quote differenziate di 30 e 40 kg/mc, rivestita con fibre termolegate. Rivestimento non sfoderabile.

Die Besonderheit von diesem Modell ist die typische abgesteppte Ausführung, völlig handgetun. Gestell: Massivholz und Multischichtplatten, von Schaumstoff-Polyurethane und Dacron bezogen. Sitzfläche: Polsterung aus unterschiedlich dichtem Schaumstoff-Polyurethane, Dichte 30 und 40 Kg/m³, in thermogebundenen Fasern bezogen. Rückenlehne: Polsterung aus unterschiedlich dichtem Schaumstoff-Polyurethane, Dichte 30 und 40 Kg/m³, in thermogebundenen Fasern bezogen. Bezug: nicht abziehbar.

The peculiarity of this model is the typical "quilting" manufacturing, all handmade. Frame: solid wood and multilayer panels covered in polyurethane foam and dacron. Seat: padding in polyurethane foam, in differentiated densities of 30 and 40 Kg/m³, covered with thermobound fibres. Back: padding in polyurethane foam in differentiated densities of 30 and 40 Kg/m³, covered with thermobound fibres. Cover: not removable

Главная отличительная особенность данной модели это прошивка по отсекам, сделанная вручную. Каркас: массив дерева в сочетании с многослойной фанерой, пенополиуретан, дакрон. Сиденье: наполнение из пенополиуретана различной плотности, 30 и 40 кг/м³, с покрытием из термосвязанных волокон. Спинка: наполнение из пенополиуретана различной плотности, 30 и 40 кг/м³ с покрытием из термосвязанных волокон. Чехлы: несъемные

La particularité de ce modèle est la typique finition piquée toute faite à main. Structure: bois massif et panneaux multicouche recouverts de polyuréthane expansé et dacron. Assise: rembourrage de polyuréthane expansé avec densités différenciées, densité 30 et 40 Kg/m³ recouverts de fibres thermoliées. Dossier: rembourrage de polyuréthane expansé avec densités différenciées, densité 30 et 40 Kg/m³ recouverts de fibres thermoliées. Revêtement: pas déhoussable

Finiture/Finishes

Top in marmo Marble top											
Code	White Carrara marble OPP1	Black Marquinia marble OPP2	Brown Emperador marble OPP3	Grey Serena stone OPP4	Beige Brera stone OPP5	Calacatta gold marble OPP7	Black and gold marble OPP9	Perfetto brown marble OPP10	Grey Stone marble OPP11	Guatemala green marble OPP12	
Code	Velvet brown marble OPP13	Amani Bronze marble OPP14	Covelano white marble OPP15	Sahara noir marble OPP16	Port Laurent marble OPP17	Arabescato orobico grey marble OPP20	Calacatta violet marble OPP21				
Top in Gres Porcellanato Porcelain Stoneware Top											
Code	Nero Marquinia OPG2	Statuario Select OPG3	Calacatta Royal OPG4								
Base in legno Wooden base											
Code	Cherry stained oak OPR1	Wengé stained oak OPR2	Walnut stained oak OPR3	Natural oak OPR4	Black stained oak OPR5	Cherry Milano stained oak OPR6					
Code	Tobacco stained oak OPR8	Grey taupe stained oak OPR9	Whitened oak OPR10	Charcoal stained oak OPR11	Mahogany stained oak OPR12	Moka matt stained oak OPR15					

Finiture base
Base finishes

Code	Shiny chrome metal OPM1	Brushed matt chrome metal OPM2	Brushed matt dark grey metal OPM3	RAL 9017 black painted metal OPM6	Classic bronze painted metal OPM9	Golden beach painted metal OPM10	Gold pearl painted metal OPM11				
Code	Brushed copper metal OPM12	Brushed antique brass metal OPM13	Brushed antique gold metal OPM15	Anodyc Bronze metal OPM18	Dark bronze painted metal OPM21	Prosecco painted metal OPM22	Tobacco painted metal OPM23				

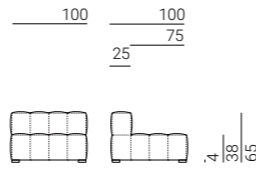

Elementi di seduta
Seat elements

Elementi laterali con schienale e bracciolo
Corner elements with backrest and armrest



9AD103
L100 P100 H65

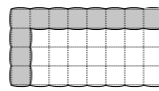
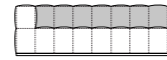

9AD132
L200 P100 H65

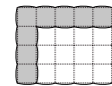
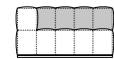

9AD124
L125 P100 H65

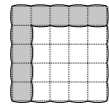

9AD125
L125 P125 H65

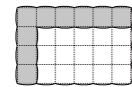

9AD126
L150 P100 H65

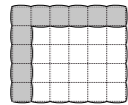

9AD127
L150 P125 H65

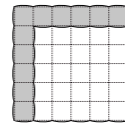

9AD128
L150 P150 H65

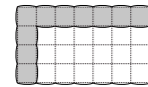
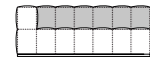

9AD129
L175 P100 H65

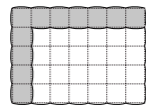

9AD130
L175 P125 H65

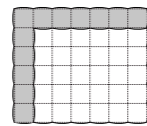

9AD131
L175 P150 H65

Elementi di seduta
Seat elements

Elementi centrali con schienale
Central elements with backrest



9AD104
L75 P100 H65



9AD102
L100 P100 H65

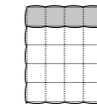

9AD113
L100 P125 H65



9AD114
L100 P150 H65



9AD200
L100 P100 H65

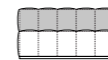

9AD115
L125 P100 H65

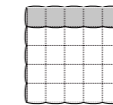

9AD116
L125 P125 H65



9AD117
L125 P150 H65

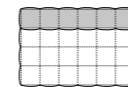

9AD118
L150 P100 H65

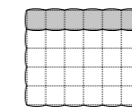

9AD119
L150 P125 H65

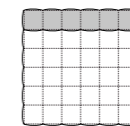

9AD120
L150 P150 H65

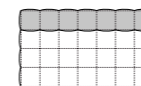
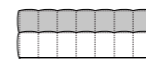

9AD121
L175 P100 H65

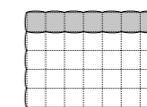

9AD122
L175 P125 H65

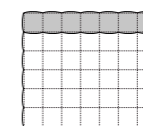

9AD123
L175 P150 H65

Pouf
Ottomans

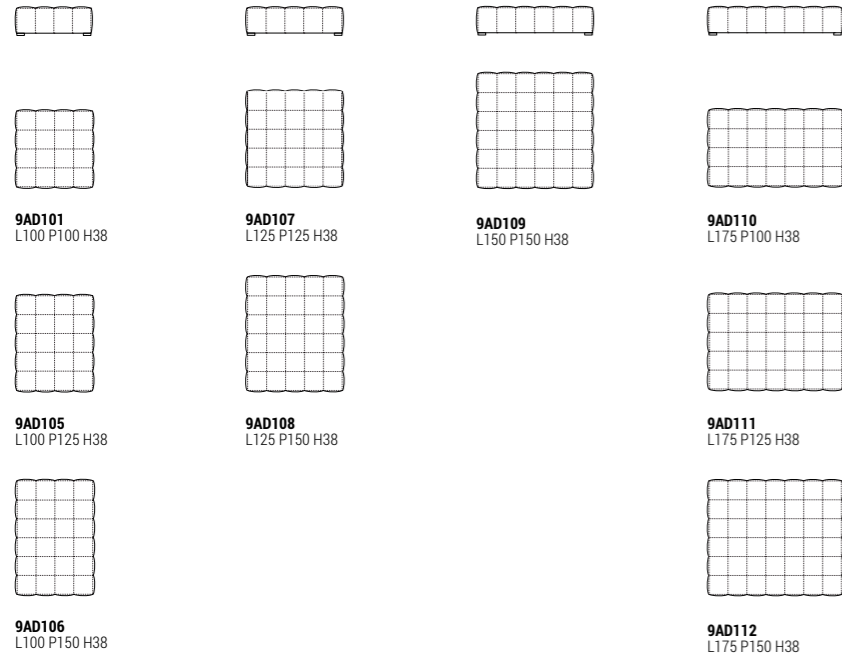

Dormeuse
Longchair

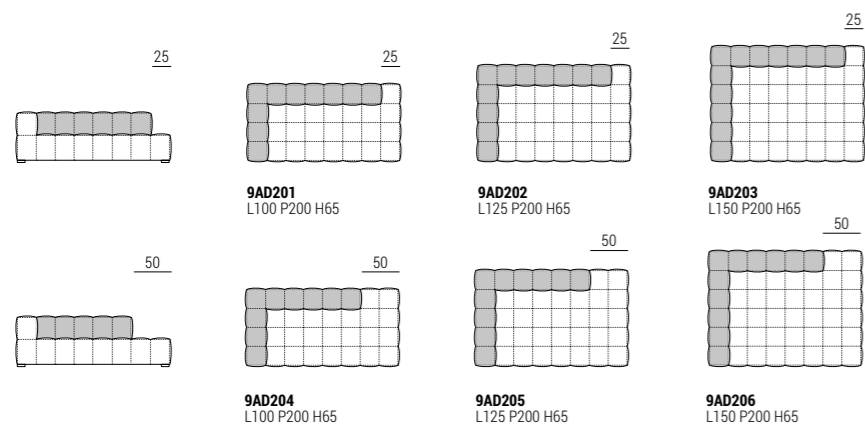

Tavoli
Tables

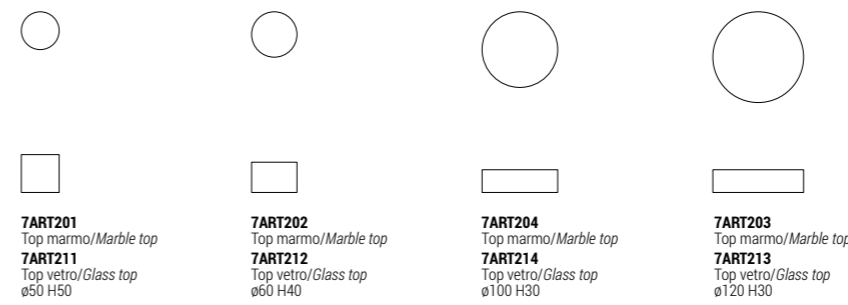

Finiture
Finishes

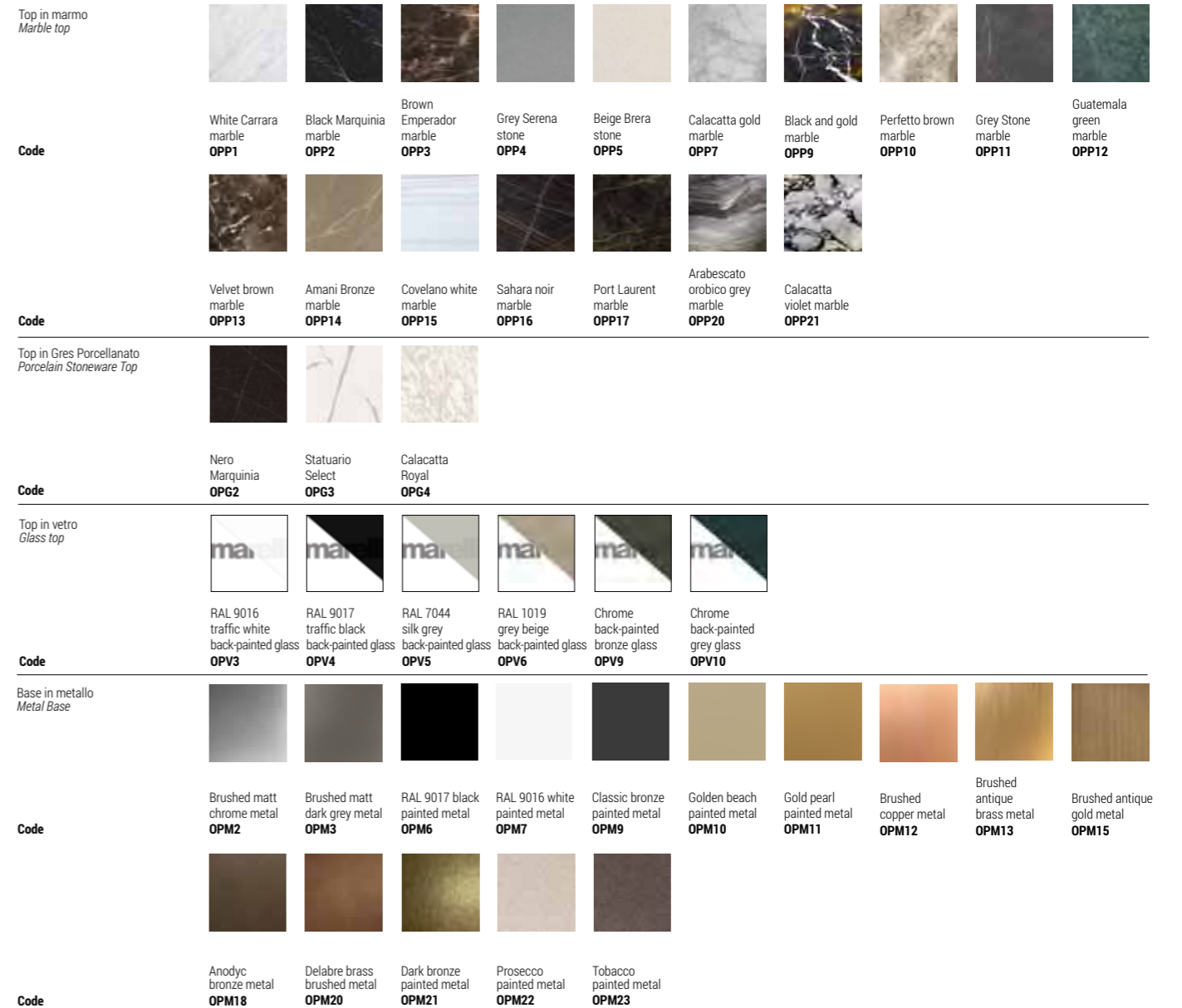

Tavoli
Tables

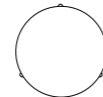

7AT101
Top marmo/Marble top
7AT111
Top vetro/Glass top
ø50 H40

7AT102
Top marmo/Marble top
7AT112
Top vetro/Glass top
ø50 H50

7AT103
Top marmo/Marble top
7AT113
Top vetro/Glass top
ø80 H30

7AT104
Top marmo/Marble top
7AT114
Top vetro/Glass top
ø100 H30

7AT105
Top marmo/Marble top
7AT115
Top vetro/Glass top
ø120 H30

Finiture
Finishes

Top in marmo
Marble top

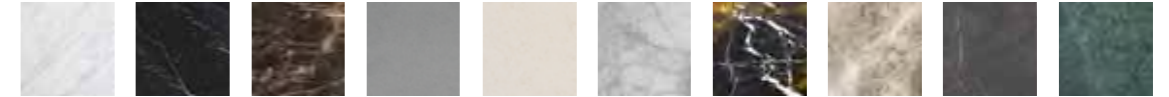

Code
White Carrara marble **OPP1** Black Marquina marble **OPP2** Brown Emperador marble **OPP3** Grey Serena stone **OPP4** Beige Brera stone **OPP5** Calacatta gold marble **OPP7** Black and gold marble **OPP9** Perfetto brown marble **OPP10** Grey Stone marble **OPP11** Guatemala green marble **OPP12**

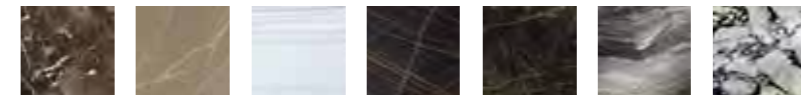

Code
Velvet brown marble **OPP13** Amani Bronze marble **OPP14** Covelano white marble **OPP15** Sahara noir marble **OPP16** Port Laurent marble **OPP17** Arabescato orobico grey marble **OPP20** Calacatta violet marble **OPP21**

Top in vetro
Glass top



Code
RAL 9016 traffic white back-painted glass **OPV3** RAL 9017 traffic black back-painted glass **OPV4** RAL 7044 silk grey back-painted glass **OPV5** RAL 1019 grey beige back-painted glass **OPV6** Chrome back-painted bronze glass **OPV9** Chrome back-painted grey glass **OPV10**

Base in metallo
Metal Base



Code
Shiny chrome metal **OPM1** Brushed matt chrome metal **OPM2** Brushed matt dark grey metal **OPM3** RAL 9017 black painted metal **OPM6** RAL 9016 white painted metal **OPM7** Classic bronze painted metal **OPM9** Golden beach painted metal **OPM10** Gold pearl painted metal **OPM11**



Code
Brushed copper metal **OPM12** Brushed antique brass metal **OPM13** Shiny black chrome metal **OPM14** Brushed antique gold metal **OPM15** Shiny brass chrome metal **OPM16** Bronze metal **OPM17** Anodyc bronze metal **OPM18** Dark bronze painted metal **OPM21** Prosecco painted metal **OPM22** Tobacco painted metal **OPM23**

Top in Gres Porcellanato
Porcelain Stoneware Top

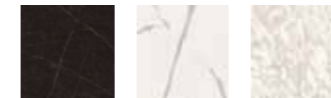

Code
Nero Marquina **OPG2** Statuario Select **OPG3** Calacatta Royal **OPG4**

Tavoli
Tables

40
28



7BR101
Top marmo/Marble top
7BR104
Top MDF/MDF top
7BR111
Top legno/Wooden top
7BR117
Top vetro/Glass top
7BR114
Top metallo/Metal top
ø40 H45

60
28



7BR102
Top marmo/Marble top
7BR105
Top MDF/MDF top
7BR112
Top legno/Wooden top
7BR118
Top vetro/Glass top
7BR115
Top metallo/Metal top
ø60 H36

80
35



7BR103
Top marmo/Marble top
7BR106
Top MDF/MDF top
7BR113
Top legno/Wooden top
7BR119
Top vetro/Glass top
7BR116
Top metallo/Metal top
ø80 H27

90
35



7BR120
Top marmo/Marble top
7BR121
Top MDF/MDF top
7BR122
Top legno/Wooden top
7BR123
Top vetro/Glass top
7BR124
Top metallo/Metal top
L90 P60 H28

Top: marmo/rovere massello/MDF, spessore 20 mm
Base: metallo, spessore 10 mm
Top: marble/solid oak/MDF, 20 mm thick
Base: metal, 10 mm thick

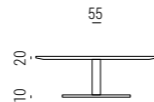

Top: metallo, spessore 10 mm
Base: metallo, spessore 10 mm
Top: metal, 10 mm thick
Base: metal, 10 mm thick

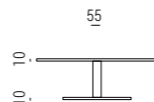

Finiture/Finishes

Top in marmo
Marble top



Code
White Carrara marble **OPP1**
Black Marquina marble **OPP2**
Brown Emperador marble **OPP3**
Grey Serena stone **OPP4**
Beige Brera stone **OPP5**
Calacatta gold marble **OPP7**
Black and gold marble **OPP9**
Perfetto brown marble **OPP10**
Grey Stone marble **OPP11**
Guatemala green marble **OPP12**

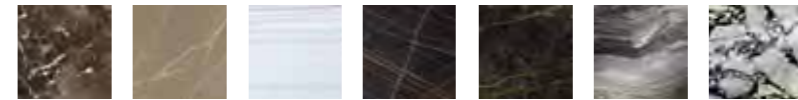

Code
Velvet brown marble **OPP13**
Amani Bronze marble **OPP14**
Covelano white marble **OPP15**
Sahara noir marble **OPP16**
Port Laurent marble **OPP17**
Arabescato orobico grey marble **OPP20**
Calacatta violet marble **OPP21**

Top in Gres Porcellanato
Porcelain Stoneware Top

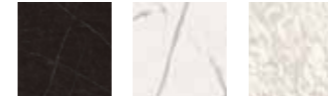

Code
Nero Marquina **OPG2**
Statuario Select **OPG3**
Calacatta Royal **OPG4**

Top in rovere massello
Solid oak top



Code
Cherry stained oak **OPR1**
Wengé stained oak **OPR2**
Walnut stained oak **OPR3**
Natural oak **OPR4**
Black stained oak **OPR5**
Cherry Milano stained oak **OPR6**



Code
Tobacco stained oak **OPR8**
Grey taupe stained oak **OPR9**
Whitened oak **OPR10**
Charcoal stained oak **OPR11**
Mahogany stained oak **OPR12**
Moka matt stained oak **OPR15**

Base/top in metallo
Metal base/top



Code
Shiny chrome metal **OPM1**
Brushed matt chrome metal **OPM2**
Brushed matt dark grey metal **OPM3**
RAL 9017 black painted metal **OPM6**
RAL 9016 white painted metal **OPM7**
Classic bronze painted metal **OPM9**
Golden beach painted metal **OPM10**
Gold pearl painted metal **OPM11**
Brushed copper metal **OPM12**
Brushed antique brass metal **OPM13**



Code
Shiny black chrome metal **OPM14**
Brushed antique gold metal **OPM15**
Shiny brass chrome metal **OPM16**
Bronze metal **OPM17**
Anodyc Bronze metal **OPM18**
Dark bronze painted metal **OPM21**
Prosecco painted metal **OPM22**
Tobacco painted metal **OPM23**

Struttura in tubolare di metallo ricoperto con schiuma di poliuretano a freddo ignifugo, classe 1IM, rivestito con una fodera in fibra acrilica. Cuscino di seduta in poliuretano espanso con densità 40 kg/m³ (5,9 KPA), rivestito in fibra acrilica. Il rivestimento è sempre fisso.

Structure en métal tubulaire recouvert de mousse à froid ignifuge classe 1IM, recouverte d'une housse en fibre acrylique. Coussin d'assise en mousse de polyuréthane avec une densité de 40 kg/m³ (5,9 kPa), recouverte de fibre acrylique.

Le revêtement est toujours fixe.

Metal tube structure upholstered with cold injected fire retardant polyurethane foam class 1IM, covered with acrylic fibre. Seat cushion in polyurethane foam with density 40 kg/m³ (5,9 KPA), lined with acrylic fibre. Fixed covers.

Каркас выполнен из профильной металлической трубы, покрытой слоем огнестойкого пенополиуретана холодного формования, класс 1 IM, и помещенной в чехол из акрилового волокна. Наполнение подушки сиденья выполнено из вспененного полиуретана плотностью 40 кг/м³ (5,9 кПа), помещенного в чехол из акрилового волокна. Обивка только несъемная.

Struktur der Sitzschale in Metall überschäumt mit Polyurethan-Kaltschaumstoff, Feuerwiderstandsklasse 1IM, mit Acrylfaser ummantelt. Sitzkissen aus Polyurethan-Schaumstoff mit Dichte 40 Kg/m³ (5,9 KPA), mit Acrylfaser ummantelt. Bezüge immer fix, nicht abziehbar.

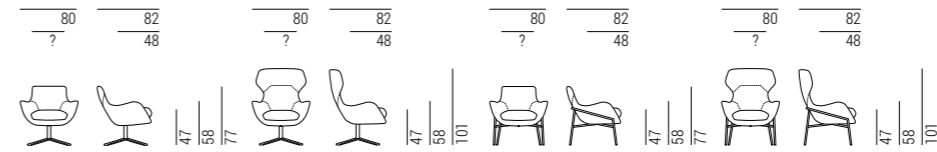

Poltrone Armchairs



9BRE101
L80 P82 H77
Swivel metal base



9BRE102
L80 P82 H77
Wood base



9BRE103
L80 P82 H77
Metal base



9BRE104
L80 P82 H101
Swivel metal base



9BRE105
L80 P82 H101
Wood base



9BRE106
L80 P82 H101
Metal base

Finiture Finishes

Base in metallo Metal base

Code	OPM1	OPM2	OPM3	OPM6	OPM7	OPM9	OPM10	OPM11	OPM12	OPM13
Code	OPM14	OPM15	OPM16	OPM17	OPM18	OPM21	OPM22	OPM23		

Base in legno Wooden base

Code	OPR1	OPR2	OPR3	OPR4	OPR5	OPR6
Code	OPR8	OPR9	OPR10	OPR11	OPR12	OPR15

Base girevole in metallo Swivel metal base

Code	OPM6	OPM9	OPM10	OPM11	OPM15	OPM18	OPM21

Chia

DESIGN
STEFANO GALLIZZOLI
2016

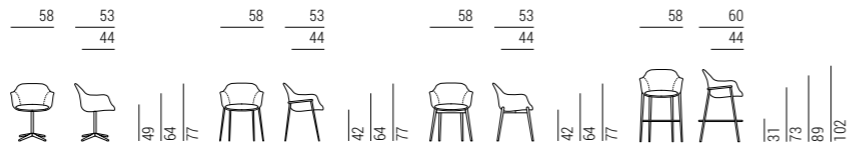

Struttura in tubolare di metallo ricoperto con schiuma di poliuretano a freddo ignifugo, classe 11M. Cuscino di seduta con struttura in Baydur® 80IK28/DO con imbottitura in poliuretano espanso con densità 40 kg/m³ (5,9 KPA), rivestito in fibra acrilica. Il rivestimento è sempre fisso. Il basamento girevole è in metallo a 4 razze. Basamento girevole in metallo disponibile in due versioni.

Structure en métal tubulaire recouvert de mousse à froid ignifuge classe 11M. Coussin d'assise avec structure en Baydur® 80IK28/DO, rembourré en mousse polyuréthane d'une densité de 40 kg/m³ (5,9 KPA), recouverte de fibre acrylique. Le revêtement est toujours fixe. Base pivotante en métal à 4 pieds. Base pivotante en métal disponible en deux versions.

Metal tube structure upholstered with cold injected fire retardant polyurethane foam class 11M. Seat cushion with structure in Baydur® 80IK28/DO upholstered with polyurethane foam with density of 40 kg/m³ (5,9 KPA), covered with acrylic fibre. Covers are always fixed. The metal swivel base is a 4-star base.

Каркас из металлического профиля, покрытого слоем огнеупорного пенополиуретана холодного отверждения класса 11M. Подушка сиденья имеет основу из Baydur® 80IK28/DO и наполнение из вспененного полиуретана плотностью 40 кг/м³ (5,9 Кпа), обернутого в акриловое волокно. Обивка подушки несъемная. Вращающееся металлическое основание имеет 4 опоры.

Struktur der Sitzschale in Metall überschäumt mit Polyurethan-Kaltschaumstoff, Feuerwiderstandsklasse 11M. Sitzkissen mit Gestell in Baydur® 80IK28/DO, gepolstert mit Polyurethanschaumstoff mit Dichte 40 Kg/m³ (5,9 KPA), mit Acrylfaser ummantelt. Bezüge immer fix, nicht abziehbar. Das Drehgestell ist in Metall, mit 4-Fusskreuz mit Standsäule. Das Drehgestell ist in Metall, in zwei Versionen erhältlich.

Baydur® - полимерный материал, производимый концерном Bayer. Металлическая поворотная основа доступна в двух версиях.

Poltrone Armchairs



9CHI103
L58 P53 H77
Poltroncina girevole
con base in metallo
Swivel armchair with metal base



9CHI104
L58 P53 H77
Poltroncina con base in metallo
Armchair with metal base



9CHI105
L58 P53 H77
Poltroncina con base in legno
Armchair with wooden base



9CHI106
L58 P60 H102
Sgabello
Bar stools



9CHI107
L58 P60 H93/112
Sgabello
Bar stools

Basi girevoli Swivel bases

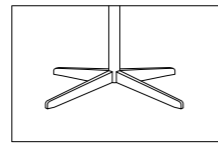

Versione A Base girevole
in metallo a 4 razze
Version A Swivel
4-star metal base

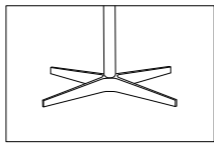

Versione B Base girevole
in metallo a 4 razze
Version B Swivel
4-star metal base

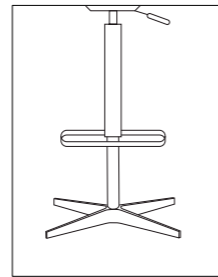

Versione C Base girevole
in metallo a 4 razze
Version c Swivel
4-star metal base

Chia

DESIGN
STEFANO GALLIZZOLI
2016

Finiture Finishes

9CHI103 Base girevole in metallo A Swivel metal base A															
Code	Shiny chrome metal OPM1	Brushed matt chrome metal OPM2	Brushed matt dark grey metal OPM3	RAL 9017 black painted metal OPM6	RAL 9016 white painted metal OPM7	Classic bronze painted metal OPM9	Golden beach painted metal OPM10	Gold pearl painted metal OPM11							
9CHI103 Base girevole in metallo B Swivel metal base B															
Code	Brushed copper metal OPM12	Brushed antique brass metal OPM13	Shiny black chrome metal OPM14	Brushed antique gold metal OPM15	Shiny brass chrome metal OPM16	Bronze metal OPM17	Anodyc Bronze painted metal OPM18	Dark bronze painted metal OPM21	Prosecco painted metal OPM22	Tobacco painted metal OPM23					
9CHI103 Base girevole in metallo B Swivel metal base B															
Code	Shiny chrome metal OPM1	Brushed matt chrome metal OPM2	RAL 9017 black painted metal OPM6	Classic bronze painted metal OPM9	Dark bronze painted metal OPM21										
9CHI104 9CHI106 base in metallo metal base															
Code	Brushed matt chrome metal OPM2	Brushed matt dark grey metal OPM3	RAL 9017 black painted metal OPM6	RAL 9016 white painted metal OPM7	Classic bronze painted metal OPM9	Golden beach painted metal OPM10	Gold pearl painted metal OPM11	Brushed copper metal OPM12	Brushed antique brass metal OPM13	Brushed antique gold metal OPM15					
9CHI105 Base in legno Wooden base															
Code	Anodyc bronze metal OPM18	Delabre pewter brushed metal OPM19	Delabre brass brushed metal OPM20	Dark bronze painted metal OPM21	Prosecco painted metal OPM22	Tobacco painted metal OPM23									
9CHI105 Base in legno Wooden base															
Code	Cherry stained oak OPR1	Wengé stained oak OPR2	Walnut stained oak OPR3	Natural oak OPR4	Black stained oak OPR5	Cherry Milano stained oak OPR6									
Code	Tobacco stained oak OPR8	Grey taupe stained oak OPR9	Whitened oak OPR10	Charcoal stained oak OPR11	Mahogany stained oak OPR12	Moka matt stained oak OPR15									

Tavoli
Tables



7CL101
Tavolino in metallo verniciato
Painted metal table
7CL107
Tavolino in metallo con top in vetro
Metal table with glass top
7CL116
Tavolino in metallo cromato
o spazzolato
Chrome/Brushed metal table
7CL124
Tavolino in metallo con top in marmo
Metal table with marble top
Ø60 H27



7CL111
Tavolino in metallo verniciato
Painted metal table
7CL121
Tavolino in metallo con top in vetro
Metal table with glass top
7CL114
Tavolino in metallo cromato
o spazzolato
Chrome/Brushed metal table
7CL133
Tavolino in metallo con top in marmo
Metal table with marble top
Ø60 H40



7CL102
Tavolino in metallo verniciato
Painted metal table
7CL108
Tavolino in metallo con top in vetro
Metal table with glass top
7CL117
Tavolino in metallo cromato
o spazzolato
Chrome/Brushed metal table
7CL125
Tavolino in metallo con top in marmo
Metal table with marble top
Ø40 H40



7CL110
Tavolino in metallo verniciato
Painted metal table
*** 7CL112**
Tavolino in metallo con top in vetro
Metal table with glass top
*** 7CL119**
Tavolino in metallo cromato
o spazzolato
Chrome/Brushed metal table
*** 7CL127**
Tavolino in metallo con top in marmo
Metal table with marble top
Ø100 H27



7CL103
Tavolino in metallo verniciato
Painted metal table
7CL109
Tavolino in metallo con top in vetro
Metal table with glass top
7CL118
Tavolino in metallo cromato
o spazzolato
Chrome/Brushed metal table
7CL126
Tavolino in metallo con top in marmo
Metal table with marble top
Ø40 H50



7CL113
Tavolino in metallo verniciato
Painted metal table
*** 7CL115**
Tavolino in metallo con top in vetro
Metal table with glass top
*** 7CL120**
Tavolino in metallo cromato
o spazzolato
Chrome/Brushed metal table
*** 7CL128**
Tavolino in metallo con top in marmo
Metal table with marble top
Ø100 H40

* Non realizzabili nelle finiture OPM1, OPM14, OPM16 e OPM17.
* Not available in the finishes OPM1, OPM14, OPM16 and OPM17.

Top: metallo, spessore 5 mm
Base: metallo, spessore 5 mm
Top: metal, 5 mm thick
Base: metal, 5 mm thick

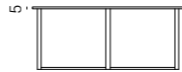

Top: vetro extra light temperato, spessore 6 mm
Base: metallo spessore 5 mm
Top: extralight tempered glass, 6 mm thick
Base: metal, 5 mm thick



Top: marmo, spessore 20 mm
Base: metallo, spessore 5 mm
Top: marble, 20 mm thick
Base: metal, 5 mm thick



Finiture
Finishes

Base in metallo
cromato o spazzolato
Chrome or brushed
metal base



Code
Shiny chrome metal **OPM1**
Brushed matt chrome metal **OPM2**
Brushed matt dark grey metal **OPM3**
Brushed copper metal **OPM12**
Brushed antique brass metal **OPM13**
Shiny black chrome metal **OPM14**
Brushed antique gold metal **OPM15**
Shiny brass chrome metal **OPM16**
Bronze metal **OPM17**



Code
Delabre pewter brushed metal **OPM19**
Delabre brass brushed metal **OPM20**
Prosecco painted metal **OPM22**
Tobacco painted metal **OPM23**

Base in metallo
verniciato
Painted
metal base



Code
RAL 9017 black painted metal **OPM6**
RAL 9016 white painted metal **OPM7**
Metal painted in RAL Classic colors **OPM8**
Classic bronze painted metal **OPM9**
Golden beach painted metal **OPM10**
Gold pearl painted metal **OPM11**
Anodyc Bronze metal **OPM18**
Dark bronze painted metal **OPM21**

Top in vetro
Glass top



Code
Transparent glass **OPV1**
Frosted glass **OPV2**
RAL 9016 traffic white back-painted glass **OPV3**
RAL 9017 traffic black back-painted glass **OPV4**
RAL 7044 silk grey back-painted glass **OPV5**
RAL 1019 grey beige back-painted glass **OPV6**



Code
Glass back-painted in the RAL classic colours **OPV7**
Chrome back-painted bronze glass **OPV9**
Chrome back-painted grey glass **OPV10**
Transparent bronze glass **OPV12**
Transparent grey glass **OPV13**

Top in marmo
Marble top



Code
White Carrara marble **OPP1**
Black Marquina marble **OPP2**
Brown Emperador marble **OPP3**
Grey Serena stone **OPP4**
Beige Brera stone **OPP5**
Calacatta gold marble **OPP7**
Black and gold marble **OPP9**
Perfetto brown marble **OPP10**
Grey Stone marble **OPP11**
Guatemala green marble **OPP12**

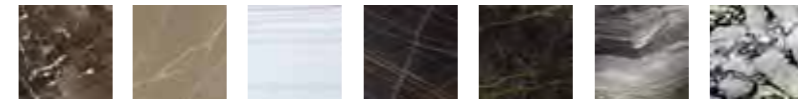

Code
Velvet brown marble **OPP13**
Amani Bronze marble **OPP14**
Covellano white marble **OPP15**
Sahara noir marble **OPP16**
Port Laurent marble **OPP17**
Arabescato orobico grey marble **OPP20**
Calacatta violet marble **OPP21**

Top in Gres Porcellanato
Porcelain Stoneware Top

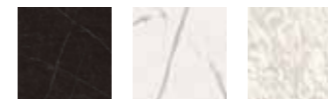

Code
Nero Marquina **OPG2**
Statuario Select **OPG3**
Calacatta Royal **OPG4**

Clipper

DESIGN
STEFANO GALLIZOLI
2019

284

LIFESTYLE COLLECTION N.2 _ MARELLI

Schienale in legno multistrato di pioppo curvato imbottito con poliuretano espanso con densità 30 kg/m³. Seduta in legno multistrato di pioppo imbottito con poliuretano espanso con densità 40 kg/m³, rivestito in dacron con cinghie elastiche intrecciate. Rivestimento fisso. Il modello è disponibile senza piedini, con basamento in legno o in metallo. Le poltrone sono disponibili anche con basamento girevole in metallo.

Dossier en bois multiplis de peuplier courbé fini de mousse de polyuréthane de densité de 30 kg/m³. Structure d'assise en bois multiplis de peuplier finie de mousse de polyuréthane de densité de 40 kg/m³ couverte de dacron, muni de bandes élastiques entrecroisées. Le revêtement est toujours fixe. Le modèle est disponible sans piètement, avec piètement en bois ou en métal. Les fauteuils sont disponibles aussi avec base pivotante en métal.

Backrest made of curved multi-ply poplar wood, upholstered with polyurethane foam with density 30 kg/m³. Seat structure made of multi-ply poplar wood, upholstered with polyurethane foam with density 40 kg/m³, covered with dacron, with interwoven elastic belts. Fixed covers. The model is available without base, with wooden or metal base. The armchairs are also available also with swivel metal base.

Спинка: гнутая многослойная фанера из тополя в сочетании со вспененным полиуретаном плотностью 30кг/м³. Сиденье: гнутая многослойная фанера из тополя в сочетании со вспененным полиуретаном плотностью 40кг/м³, обернутым в дакрон. Подвеска из перекрещивающихся эластичных ремней. Обивка съёмная. Помимо ножек диван может иметь деревянное либо металлическое основание. Кресла могут иметь поворотное металлическое основание.

Rückenlehne aus gebogenem Pappelschichtholz, gepolstert mit Polyurethan-Schaumstoff mit Dichte 30 Kg/m³. Sitzstruktur aus Pappelschichtholz, gepolstert mit Polyurethan-Schaumstoff mit Dichte 40 Kg/m³, mit Dacron Ummantelt, mit gefrochtenen Gummigurten. Clipper ist immer festbezogen. Das Modell ist ohne Fussgestell, mit Fussgestell in Holz oder Metall erhältlich. Die Sessel sind auch mit Drehgestell in Metall lieferbar.

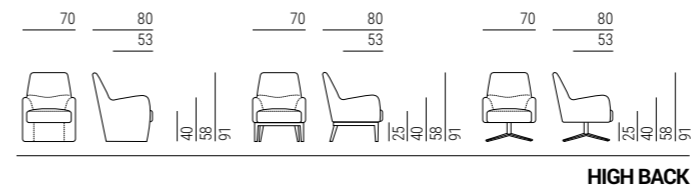

Poltrone e divani Armchairs and Sofas



9CLX101
L70 P80 H91



9CLX102
L70 P80 H91
Base in legno
Wooden base



9CLX103
L70 P80 H91
Base in metallo
Metal base



9CLX104
L70 P80 H91
Base metallo girevole
Metal swivel base

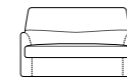

9CLX201
L150 P80 H91

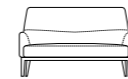

9CLX203
L150 P80 H91
Base in legno
Wooden base

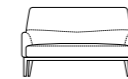

9CLX205
L150 P80 H91
Base in metallo
Metal base



9CLX202
L170 P80 H91



9CLX204
L170 P80 H91
Base in legno
Wooden base

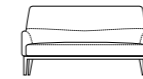

9CLX206
L170 P80 H91
Base in metallo
Metal base

Finiture Finishes

Base legno
Wooden base



Code
Cherry stained oak **OPR1** | Wengé stained oak **OPR2** | Walnut stained oak **OPR3** | Natural oak **OPR4** | Black stained oak **OPR5** | Cherry Milano stained oak **OPR6**



Code
Tobacco stained oak **OPR8** | Grey taupe stained oak **OPR9** | Whitened oak **OPR10** | Charcoal stained oak **OPR11** | Mahogany stained oak **OPR12** | Moka matt stained oak **OPR15**

Base metallo
Metal base



Code
Shiny chrome metal **OPM1** | Brushed matt chrome metal **OPM2** | Brushed matt dark grey metal **OPM3** | RAL 9017 black painted metal **OPM6** | RAL 9016 white painted metal **OPM7** | Classic bronze painted metal **OPM9**



Code
Golden beach painted metal **OPM10** | Gold pearl painted metal **OPM11** | Brushed copper metal **OPM12** | Brushed antique brass metal **OPM13** | Shiny black chrome metal **OPM14** | Brushed antique gold metal **OPM15** | Shiny brass chrome metal **OPM16** | Bronze metal **OPM17** | Anodized Bronze painted metal **OPM18** | Dark bronze painted metal **OPM21**

Clipper

DESIGN
STEFANO GALLIZOLI
2019

285

LIFESTYLE COLLECTION N.2 _ MARELLI

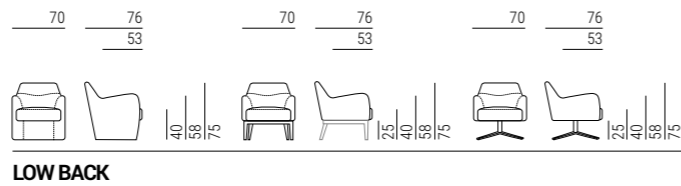

Poltrone e divani
Armchairs and Sofas

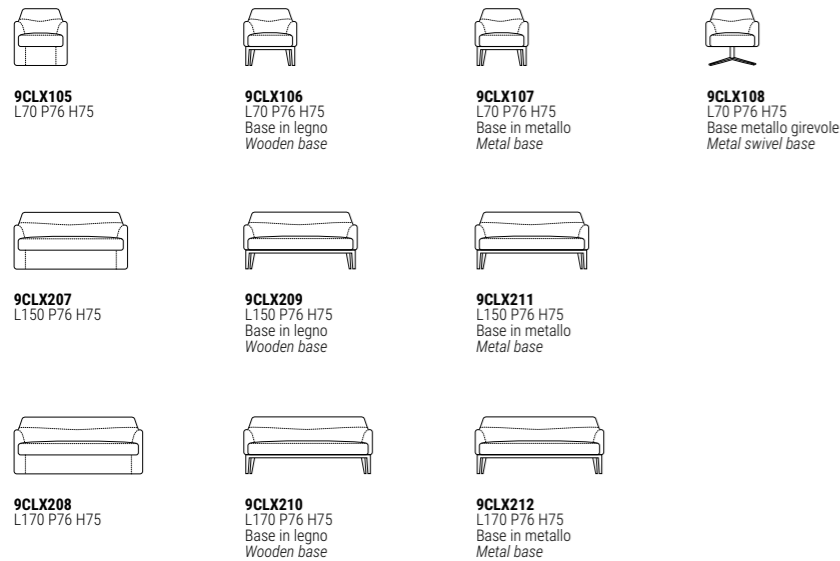

Finiture
Finishes

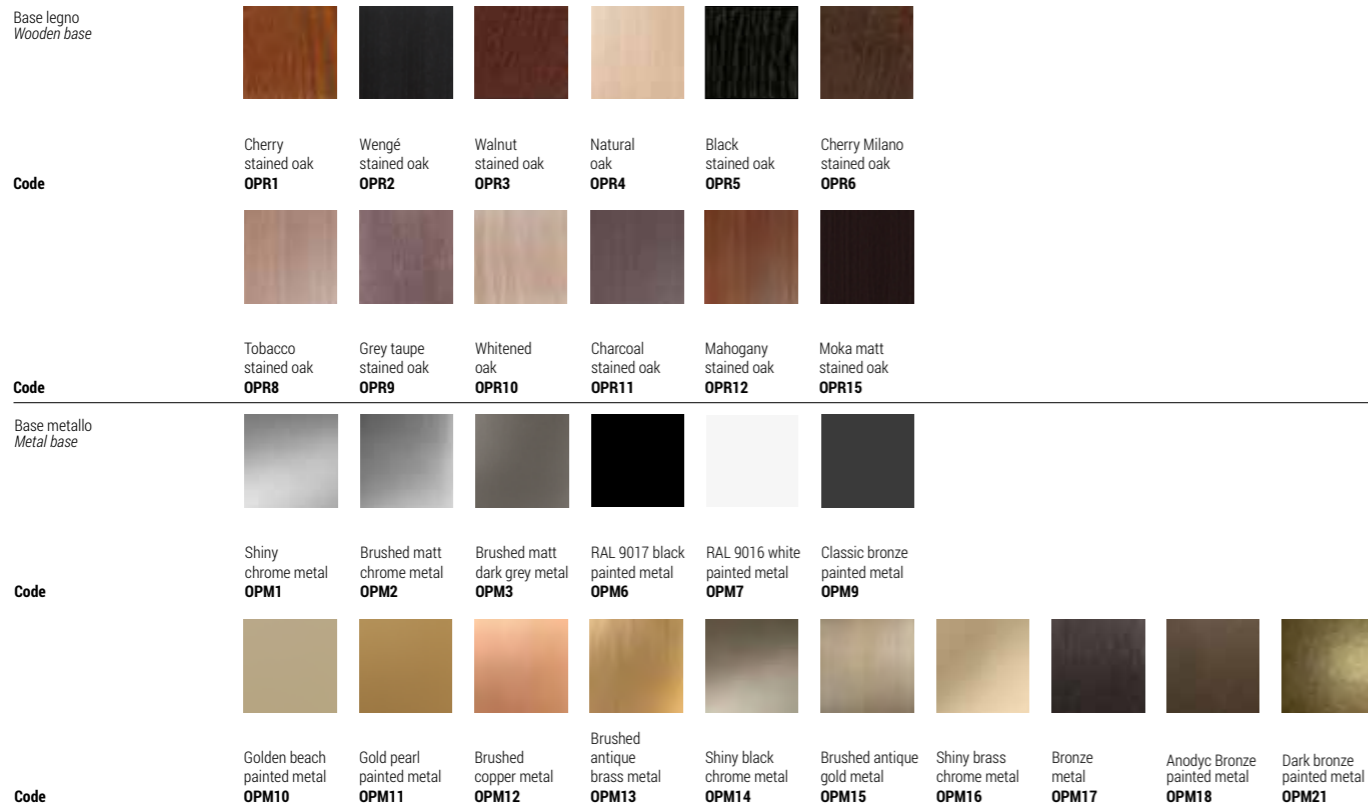

Fusto in legno massello e legno multistrato con cinghie elastiche intrecciate. Imbottitura in poliuretano espanso rivestito in vellutino bianco. Cuscini di schienale in Piumafib, una speciale miscela ipoallergenica di vera piuma e fibra poliestere siliconata*. Cuscini di seduta costituiti da un inserto in poliuretano con densità di 30 Kg/m³ ricoperto da un trapuntino di vera piuma imbottito a scomparti*. Completamente sfoderabile in tessuto, non sfoderabile in pelle e finta pelle.
Kit letto non disponibile.
*Manutenzione dei cuscini contenenti piuma: I cuscini contenenti piuma tendono a deformarsi con l'utilizzo. Per mantenerne la forma è necessario, anche dopo un breve utilizzo, battere e sprimacciare ripetutamente i cuscini. Non utilizzare mai battipanni o aspirapolvere. A coloro che non desiderassero seguire queste indicazioni o che volessero un divano dall'aspetto meno vissuto, raccomandiamo di preferire dei cuscini in gomma.

Carcasse en bois massif et multiplis muni de bandes élastiques entrecroisées et finie de mousse polyuréthane couverte de dacron. Coussins de dossier en Piumafib, un mélange hypoallergénique spécial de véritable duvet et fibre polyester siliconisée. Les coussins d'assise sont composés d'un noyau en mousse polyuréthane d'une densité de 30 kg/m³ couvert de véritable duvet broché en compartiments*. Revêtement complètement déhoussable en tissu, fixe en cuir et cuir look. Pas disponible en canapé-lit.
Entretien de coussins en duvet: Coussins en duvet ont tendance à perdre leur forme dû à l'usage. Pour en conserver la forme il est nécessaire, aussi après un usage court, de régulièrement battre les coussins. Ne jamais utiliser la tapette ou l'aspirateur. A ceux qui ne désirent pas suivre ces indications ou qui souhaitent un canapé qui ait l'air moins "usé", nous conseillons vivement de choisir des coussins en mousse polyuréthane.

Frame made of solid wood and multi-ply wood with interwoven elastic straps. The upholstery is made of polyurethane foam, covered with dacron. The back cushions are filled with Piumafib, a special hypoallergenic mixture of feathers and siliconised polyfibre*. The seat cushions are made of a foam insert with density of 30 Kg/m³, covered with a feather compartments quilt*. Fully removable fabric covers, fixed leather and artificial leather covers. Sofa-bed is not available.
*Maintenance of feather cushions: Cushions filled with feathers tend to change their shape with use. In order to keep their shape it is necessary, even after a short use, to plump up the cushions repeatedly. Never use carpet beater or vacuum cleaner. We recommend to choose foam cushions to those who do not wish to follow these instructions or to have a "used look" sofa.

Для производства каркаса используется массив дерева и многослойная фанера в сочетании с перекрещивающимися эластичными ремнями. Наполнение из полиуретана, обернутого в белый бархат. Наполнение подушек спинки выполнено из материала Piumafib – специальной, не вызывающей аллергию смеси из натурального пуха и полиэфирных силиконовых волокон*. Подушки сиденья: стеганые по отсекам, наполнение из натурального пуха с вставками из полиуретана плотностью 30 кг/м³ *. Полностью съемные чехлы из ткани, несъемные чехлы из кожи.

Das Gestell besteht aus Massiv- und Schichtholz, mit geflochtenen Gummigurten, gepolstert mit Polyurethanschaumstoff, mit Dacron bezogen. Rueckenkissen aus Piumafib, einer hypoallergischen speziellen Mischung aus echter Daune und silikonisierter Polyesterfaser*. Die Sitzkissen bestehen aus einem Schaumkern mit Dichte 30 Kg/m³ mit einer gekammerten Daunenaufgabe*. Stoffbezüge alle abziehbar, Leder und Kunstleder festbezogen. Als Bettsofa nicht verfügbar. Wartungsanleitungen fuer Daunenkissen: Die Kissen, die Daunen enthalten, neigen dazu, sich durch Gebrauch zu verformen. Um die urspruengliche Form zu halten, ist es notwendig, auch nach kurzem Gebrauch, die Kissen wiederholt aufzuschuetteln. Keinen Ausklopfen oder Staubsauger verwenden. Unseren Kunden, die diese Anweisungen nicht befolgen moechten, oder die kein Sofa mit solchem "gebrauchten" Aussehen haben moechten, empfehlen wir Polyurethan-Kissen.

Вариант со спальным местом не предусмотрен. *Эксплуатация подушек с пуховым наполнением: В процессе эксплуатации подушки с пуховым наполнением могут деформироваться, во избежание чего их необходимо слегка взбивать вручную даже после непродолжительного нахождения на диване. Использование в этих целях пылесоса или выбивалки для одежды категорически запрещено. Если клиент не планирует следовать данным инструкциям и хочет, чтобы подушки сиденья и спинки проминались по минимуму, посоветуйте выбрать наполнение только из полиуретана, полностью исключив натуральный пух.

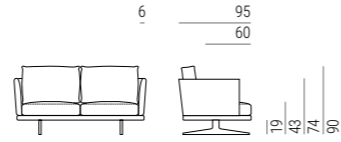

Divani
Sofas

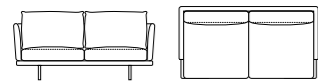

9CLP201
L184 P95 H90

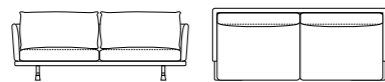

9CLP202
L224 P95 H90

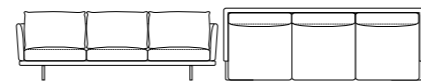

9CLP203
L264 P95 H90

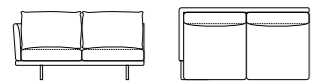

9CLP204
L172 P95 H90

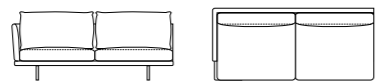

9CLP205
L212 P95 H90

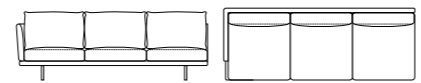

9CLP206
L252 P95 H90

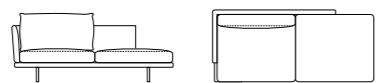

9CLP207
L212 P95 H90

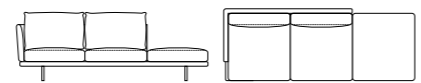

9CLP208
L252 P95 H90

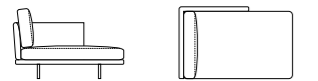

9CLP209
L144 P95 H90

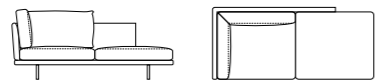

9CLP212
L212 P95 H90

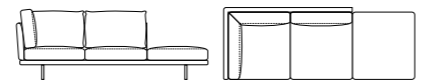

9CLP213
L252 P95 H90

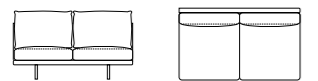

9CLP214
L160 P95 H90

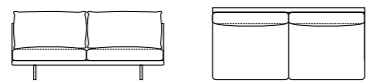

9CLP215
L200 P95 H90

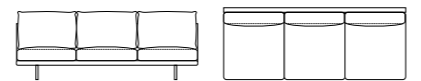

9CLP216
L240 P95 H90

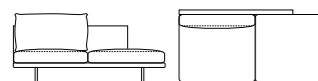

9CLP217
L200 P95 H90



9CLP218
L240 P95 H90



9CLP219
L264 P95 H90

Accessori Accessories

Cuscinetto in piuma
senza fascia
Feather cushion
without band



9CU103
L40 H40

Cuscino in piuma
senza fascia
Feather back cushion
without band



9CU106
L45 P45

Cuscinetto in piuma
senza fascia
Feather cushion
without band



9CUT103
L40 H40

Cuscino in piuma
senza fascia
Feather back cushion
without band



9CUT106
L45 P45

Finiture Finishes

Base metallo
Metal base



Code

Shiny chrome metal **OPM1** | Brushed matt chrome metal **OPM2** | Brushed matt dark grey metal **OPM3** | RAL 9017 black painted metal **OPM6** | RAL 9016 white painted metal **OPM7** | Classic bronze painted metal **OPM9** | Golden beach painted metal **OPM10** | Gold pearl painted metal **OPM11**



Code

Brushed copper metal **OPM12** | Brushed antique brass metal **OPM13** | Shiny black chrome metal **OPM14** | Brushed antique gold metal **OPM15** | Shiny brass chrome metal **OPM16** | Bronze metal **OPM17** | Anodyc Bronze painted metal **OPM18** | Dark bronze painted metal **OPM21**

Clipper Chair

DESIGN
STEFANO GALLIZOLI
2021

290

LIFESTYLE COLLECTION N.2 _ MARELLI

Schienale in legno multistrato di pioppo curvato imbottito con poliuretano espanso con densità 30 kg/m³. Seduta in legno multistrato di pioppo imbottito con poliuretano espanso con densità 40 kg/m³, rivestito in dacron con cinghie elastiche intrecciate. Rivestimento fisso.

Dossier en bois multiplis de peuplier courbé fini de mousse de polyuréthane de densité de 30 kg/m³. Structure d'assise en bois multiplis de peuplier finie de mousse de polyuréthane de densité de 40 kg/m³ couverte de dacron, muni de bandes élastiques entrecroisées. Le revêtement est toujours fixe.

Backrest made of curved multi-ply poplar wood, upholstered with polyurethane foam with density 30 kg/m³. Seat structure made of multi-ply poplar wood, upholstered with polyurethane foam with density 40 kg/m³, covered with dacron, with interwoven elastic belts. Fixed covers.

Спинка: гнутая многослойная фанера из тополя в сочетании со вспененным полиуретаном плотностью 30кг/м³. Сиденье: гнутая многослойная фанера из тополя в сочетании со вспененным полиуретаном плотностью 40кг/м³, обернутым в дакрон. Подвеска из перекрещивающихся эластичных ремней. Обивка съёмная.

Rückenlehne aus gebogenem Pappelschichtholz, gepolstert mit Polyurethan-Schaumstoff mit Dichte 30 Kg/m³. Sitzstruktur aus Pappelschichtholz, gepolstert mit Polyurethan-Schaumstoff mit Dichte 40 Kg/m³, mit Dacron Ummantelt, mit gefrochtenen Gummigurten. Clipper ist immer festbezogen.

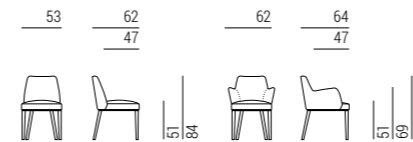

Sedie
Chairs



9CLX301
Base in legno/Wooden base
9CLX302
Base in metallo/Metal base
L53 P62 H84



9CLX303
Base in legno/Wooden base
9CLX304
Base in metallo/Metal base
L62 P64 H86

Finiture
Finishes

Base legno
Wooden base

Code	Cherry stained oak OPR1	Wengé stained oak OPR2	Walnut stained oak OPR3	Natural oak OPR4	Black stained oak OPR5	Cherry Milano stained oak OPR6
Code	Tobacco stained oak OPR8	Grey taupe stained oak OPR9	Whitened oak OPR10	Charcoal stained oak OPR11	Mahogany stained oak OPR12	Moka matt stained oak OPR15

Base metallo
Metal base

Code	RAL 9017 traffic black painted metal OPM6	RAL 9016 white painted metal OPM7	Classic bronze painted metal OPM9	Golden beach painted metal OPM10	Gold pearl painted metal OPM11	Brushed antique gold metal OPM15	Anodyc Bronze painted metal OPM18	Dark bronze painted metal OPM21

Clipper Chair

DESIGN
STEFANO GALLIZOLI
2021

291

LIFESTYLE COLLECTION N.2 _ MARELLI

Frame

DESIGN
STUDIO MARELLI
2009

292

LIFESTYLE COLLECTION N.2 _ MARELLI

Tavoli Tables



7FR101
Top in vetro/Glass top
7FR111
Top in legno/Wooden top
7FR123
Top in marmo/Marble top
L70 P70 H28

7FR102
Top in vetro/Glass top
7FR112
Top in legno/Wooden top
7FR124
Top in marmo/Marble top
L120 P70 H28

7FR103
Top in vetro/Glass top
7FR113
Top in legno/Wooden top
7FR125
Top in marmo/Marble top
L100 P100 H28

7FR131
Top in vetro/Glass top
7FR136
Top in legno/Wooden top
7FR139
Top in marmo/Marble top
L70 P70 H40

7FR132
Top in vetro/Glass top
7FR137
Top in legno/Wooden top
7FR140
Top in marmo/Marble top
L120 P70 H40

7FR133
Top in vetro/Glass top
7FR138
Top in legno/Wooden top
7FR141
Top in marmo/Marble top
L100 P100 H40

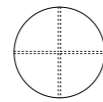
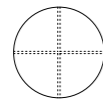

7FR104
Top in vetro/Glass top
7FR147
Top in legno/Wooden top
7FR121
Top in marmo/Marble top
Ø100 H28

7FR105
Top in vetro/Glass top
7FR148
Top in legno/Wooden top
7FR122
Top in marmo/Marble top
Ø120 H28

7FR134
Top in vetro/Glass top
7FR149
Top in legno/Wooden top
7FR142
Top in marmo/Marble top
Ø100 H40

7FR135
Top in vetro/Glass top
7FR150
Top in legno/Wooden top
7FR143
Top in marmo/Marble top
Ø120 H40

7FR151
Top in vetro/Glass top
7FR152
Top in legno/Wooden top
7FR153
Top in marmo/Marble top
L50 P50 H50

7FR106
Top in vetro/Glass top
7FR116
Top in legno/Wooden top
7FR126
Top in marmo/Marble top
L35 P35 H52



7FR162
Top in legno/Wooden top
7FR163
Top in marmo/Marble top
7FR164
Top in vetro/Glass top
Ø40 H40

7FR165
Top in legno/Wooden top
7FR166
Top in marmo/Marble top
7FR167
Top in vetro/Glass top
Ø40 H50

7FR168
Top in legno/Wooden top
7FR169
Top in marmo/Marble top
7FR170
Top in vetro/Glass top
Ø60 H40

7FR171
Top in legno/Wooden top
7FR172
Top in marmo/Marble top
7FR173
Top in vetro/Glass top
Ø60 H40

Frame

DESIGN
STUDIO MARELLI
2009

293

LIFESTYLE COLLECTION N.2 _ MARELLI

Tavoli Tables

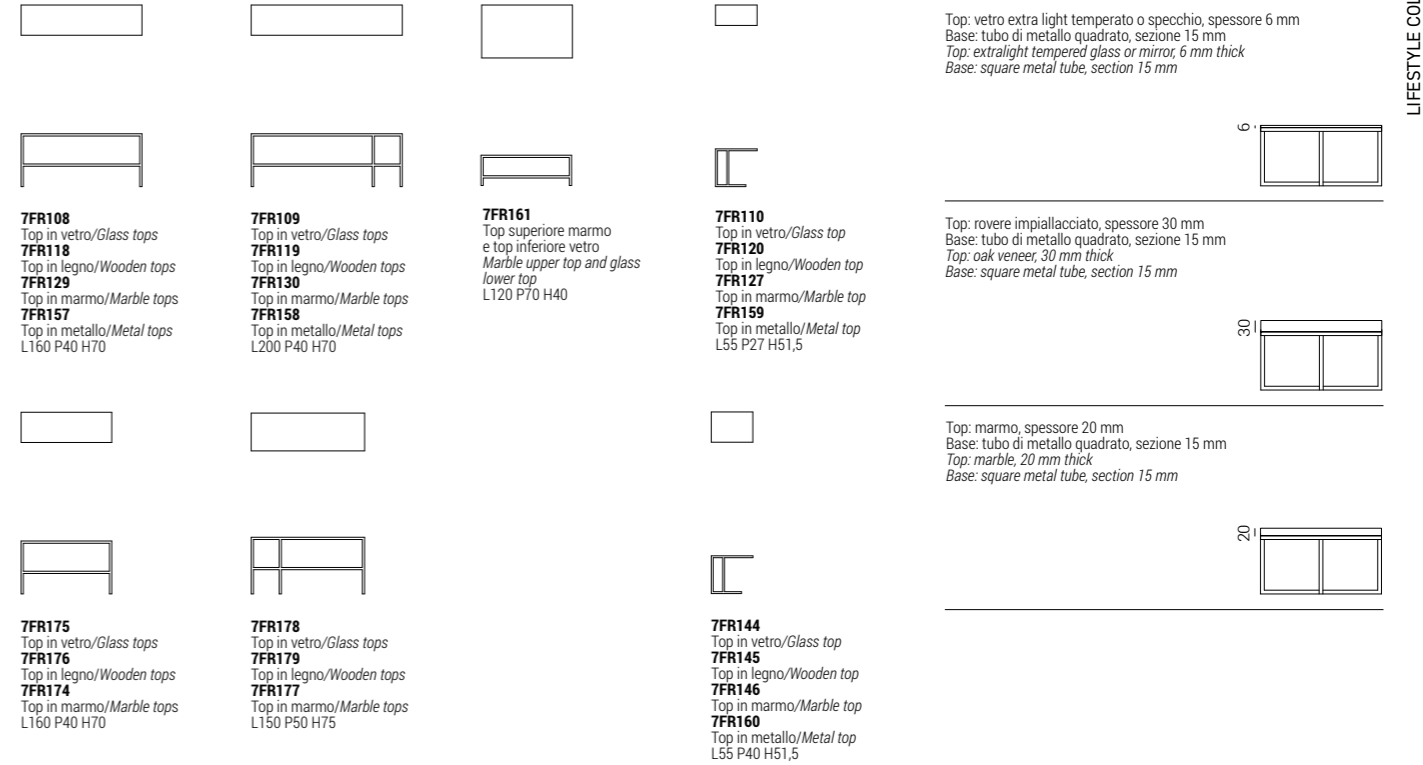

7FR108
Top in vetro/Glass tops
7FR118
Top in legno/Wooden tops
7FR129
Top in marmo/Marble tops
7FR157
Top in metallo/Metal tops
L160 P40 H70

7FR109
Top in vetro/Glass tops
7FR119
Top in legno/Wooden tops
7FR130
Top in marmo/Marble tops
7FR158
Top in metallo/Metal tops
L200 P40 H70

7FR161
Top superiore marmo
e top inferiore vetro
Marble upper top and glass
lower top
L120 P70 H40

7FR110
Top in vetro/Glass top
7FR120
Top in legno/Wooden top
7FR127
Top in marmo/Marble top
7FR159
Top in metallo/Metal top
L55 P27 H51,5

Top: vetro extra light temperato o specchio, spessore 6 mm
Base: tubo di metallo quadrato, sezione 15 mm
Top: extralight tempered glass or mirror, 6 mm thick
Base: square metal tube, section 15 mm

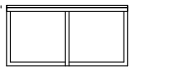

Top: rovere impiallacciato, spessore 30 mm
Base: tubo di metallo quadrato, sezione 15 mm
Top: oak veneer, 30 mm thick
Base: square metal tube, section 15 mm



Top: marmo, spessore 20 mm
Base: tubo di metallo quadrato, sezione 15 mm
Top: marble, 20 mm thick
Base: square metal tube, section 15 mm



7FR175
Top in vetro/Glass tops
7FR176
Top in legno/Wooden tops
7FR174
Top in marmo/Marble tops
L160 P40 H70

7FR178
Top in vetro/Glass tops
7FR179
Top in legno/Wooden tops
7FR177
Top in marmo/Marble tops
L150 P50 H75

7FR144
Top in vetro/Glass top
7FR145
Top in legno/Wooden top
7FR146
Top in marmo/Marble top
7FR160
Top in metallo/Metal top
L55 P40 H51,5









































Frame

DESIGN
STUDIO MARELLI
2009

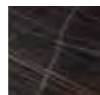
294

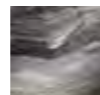
LIFESTYLE COLLECTION N.2 _ MARELLI

Finiture Finishes

Top in vetro Glass top										
Code	Transparent glass OPV1	Frosted glass OPV2	RAL 9016 traffic white back-painted glass OPV3	RAL 9017 traffic black back-painted glass OPV4	RAL 7044 silk grey back-painted glass OPV5	RAL 1019 grey beige back-painted glass OPV6	Chrome back-painted bronze glass OPV9	Chrome back-painted grey glass OPV10	Transparent bronze glass OPV12	Transparent grey glass OPV13
Top in legno Wooden top										
Code	Cherry stained oak OPR1	Wengé stained oak OPR2	Walnut stained oak OPR3	Natural oak OPR4	Black stained oak OPR5	Cherry Milano stained oak OPR6	Tobacco stained oak OPR8			
										
Code	Grey taupe stained oak OPR9	Whitened oak OPR10	Charcoal stained oak OPR11	Mahogany stained oak OPR12	Moka matt stained oak OPR15					
Top in marmo Marble top										
Code	White Carrara marble OPP1	Black Marquinia marble OPP2	Brown Emperador marble OPP3	Grey Serena stone OPP4	Beige Brera stone OPP5	Calacatta gold marble OPP7	Black and gold marble OPP9	Perfetto brown marble OPP10	Grey Stone marble OPP11	Guatemala green marble OPP12
										
Code	Velvet brown marble OPP13	Amani Bronze marble OPP14	Covelano white marble OPP15	Sahara noir marble OPP16	Port Laurent marble OPP17	Arabescato orobico grey marble OPP20	Calacatta violet marble OPP21			
Top in Gres Porcellanato Porcelain Stoneware Top										
Code	Nero Marquinia OPG2	Statuario Select OPG3	Calacatta Royal OPG4							











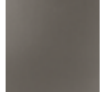

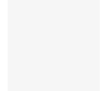



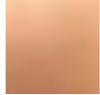

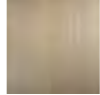





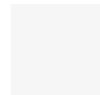

Frame

DESIGN
STUDIO MARELLI
2009

295

LIFESTYLE COLLECTION N.2 _ MARELLI

Finiture Finishes

Top in metallo Metal top										
Code	Brushed matt dark grey metal OPM3	RAL 9017 black painted metal OPM6	RAL 9016 white painted metal OPM7	Classic bronze painted metal OPM9	Golden beach painted metal OPM10	Gold pearl painted metal OPM11				
										
Code	Brushed copper metal OPM12	Brushed antique brass metal OPM13	Brushed antique gold metal OPM15	Anodyc Bronze metal OPM18	Dark bronze painted metal OPM21					
Base in metallo Metal base										
Code	Shiny chrome metal OPM1	Brushed matt chrome metal OPM2	Brushed matt dark grey metal OPM3	RAL 9017 black painted metal OPM6	RAL 9016 white painted metal OPM7	Classic bronze painted metal OPM9	Golden beach painted metal OPM10	Gold pearl painted metal OPM11		
										
Code	Brushed copper metal OPM12	Brushed antique brass metal OPM13	Shiny black chrome metal OPM14	Brushed antique gold metal OPM15	Shiny brass chrome metal OPM16	Bronze metal OPM17	Anodyc Bronze metal OPM18	Dark bronze painted metal OPM21		

Fusto in legno massello e legno multistrato con cinghie elastiche intrecciate. Imbottitura in poliuretano espanso rivestito in vellutino bianco. Sedute e schienali costituiti da un cuore in poliuretano espanso a quote differenziate 30 Kg/m³ e 40 Kg/m³, ricoperto da un trapuntino di vera piuma imbottito a scomparti*. Completamente sfoderabile in tessuto, non sfoderabile in pelle e finta pelle. Kit letto non disponibile.

*Manutenzione dei cuscini contenenti piuma: I cuscini contenenti piuma tendono a deformarsi con l'utilizzo. Per mantenerne la forma è necessario, anche dopo un breve utilizzo, battere e sprimacciare ripetutamente i cuscini. Non utilizzare mai battipanni o aspirapolvere. A coloro che non desiderassero seguire queste indicazioni o che volessero un divano dall'aspetto meno vissuto, raccomandiamo di preferire dei cuscini in gomma.

Carcasse en bois massif et multiplis muni de bandes élastiques entrecroisées et finie de mousse polyuréthane couverte de dacron. Assises et dossiers composés d'un noyau en mousse polyuréthane de différentes densités de 30 kg/m³ et 40 kg/m³ couvert de véritable duvet matelassé en compartiments. Revêtement complètement déhoussable en tissu, fixe en cuir et cuir look. Pas disponible en canapé-lit. *Entretien de coussins en duvet: Coussins en duvet ont tendance à perdre leur forme dû à l'usage. Pour en conserver la forme il est nécessaire, aussi après un usage court, de régulièrement battre les coussins. Ne jamais utiliser la tapette ou l'aspirateur. À ceux qui ne désirent pas suivre ces indications ou qui souhaitent un canapé qui ait l'air moins "usé", nous conseillons vivement de choisir des coussins en mousse polyuréthane.*

Frame made of solid wood and multi-ply wood with interwoven elastic belts. The upholstery is made of polyurethane foam, covered with dacron. Seats and backs are made of a polyurethane foam core in different densities of 30 Kg/m³ and 40 Kg/m³, covered with a feather compartments quilt. Fully removable fabric covers, fixed leather and artificial leather covers. Sofa-bed is not available.*

*Maintenance of feather cushions: Cushions filled with feathers tend to change their shape with use. In order to keep their shape it is necessary, even after a short use, to plump up the cushions repeatedly. Never use carpet beater or vacuum cleaner. We recommend to choose foam cushions to those who do not wish to follow these instructions or to have a "used look" sofa.

Каркас из массива дерева в сочетании с многослойной фанерой покрыт слоем вспененного полиуретана плотностью 40 кг/м³, обернутого в дакрон, подвеска из перекрещивающихся эластичных ремней. В основе наполнения подушек сиденья и спинки вспененный полиуретан различной степени плотности – 30 и 40 кг/м³, покрытый стеганым полотном с наполнением из натурального пуха. Целиком съёмные чехлы в ткани и несъёмные в коже, как натуральной, так и искусственной. Уход за подушками с наполнением из натурального пуха:

Das Gestell besteht aus Massiv- und Schichtholz, mit geflochtenen Gummigurten, gepolstert mit Polyurethanschaumstoff, mit Dacron bezogen. Sitze und Rücken bestehen aus einem Schaumkern in verschiedenen Dichten von 30 Kg/m³ und 40 Kg/m³ mit einer gekammerten Daunenauflage. Stoffbezüge alle abziehbar, Leder und Kunstleder festbezogen. Als Bettsofa nicht verfügbbar. *Wartungsanleitungen fuer Daunenkissen: Die Kissen, die Daunen enthalten, neigen dazu, sich durch Gebrauch zu verformen. Um die ursprüngliche Form zu halten, ist es notwendig, auch nach kurzem Gebrauch, die Kissen wiederholt aufzuschütteln. Keinen Ausklopfer oder Staubsauger verwenden. Unseren Kunden, die diese Anweisungen nicht befolgen moechten, oder die kein Sofa mit solchem "gebrauchten" Aussehen haben moechten, empfehlen wir Polyurethan-Kissen.*

В процессе эксплуатации подушек с наполнением из натурального пуха естественным их деформация неизбежна. Чтобы сохранить форму подушек, их необходимо регулярно взбивать, при этом ни в коем случае не прибегая к использованию выбивалки для одежды или пылесоса. Заказчикам, которые не будут следовать данной рекомендации либо просто предпочитают диваны с недеформируемыми подушками, фабрика рекомендует заказывать наполнение из полиуретана.

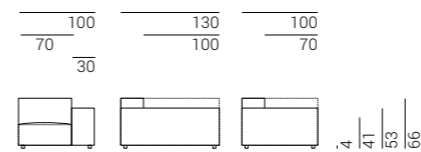

Elementi componibili Modular elements

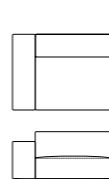

9GY201
Laterale con bracciolo basso
Side element with low armrest
L130 P100 H66

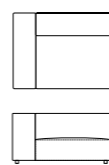

9GY204
Laterale con bracciolo alto
Side element with high armrest
L130 P100 H66

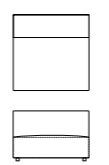

9GY301
Elemento centrale
Central element
L100 P100 H66

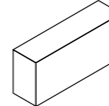

9GY502
Elemento schienale/bracciolo
Back/armrest element
L130 P30 H50

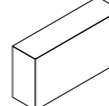

9GY504
Elemento schienale/bracciolo
Back/armrest element
L130 P30 H60

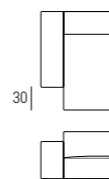

9GY202
Laterale con bracciolo basso
Side element with low armrest
L130 P130 H66

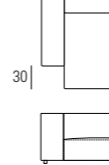

9GY205
Laterale con bracciolo alto
Side element with high armrest
L130 P130 H66

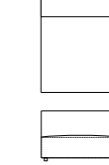

9GY302
Elemento centrale
Central element
L100 P130 H66

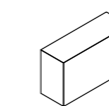

9GY501
Elemento schienale/bracciolo
Back/armrest element
L100 P30 H50

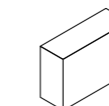

9GY503
Elemento schienale/bracciolo
Back/armrest element
L100 P30 H60

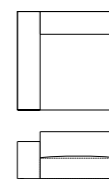

9GY203
Laterale con bracciolo basso
Side element with low armrest
L130 P130 H66

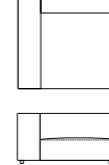

9GY206
Laterale con bracciolo alto
Side element with high armrest
L130 P130 H66

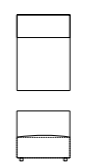

9GY303
Elemento centrale
Central element
L70 P100 H66



9GY505
Elemento schienale/bracciolo
Back/armrest element
L70 P30 H50

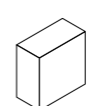

9GY505
Elemento schienale/bracciolo
Back/armrest element
L70 P30 H60



9GY401
L100 P100 H41



9GY402
L100 P130 H41



9GY403
L100 P70 H41



9GY404
L70 P70 H41

Accessori Accessories

Cuscino in piuma con profilo
Feather cushions with piping



9GY101
L40 P40

Cuscino in piuma con profilo
Feather cushions with piping



9GY102
L45 P45

Cuscino in piuma con profilo
Feather cushions with piping



9GY103
L60 P60

Madia
Sideboard

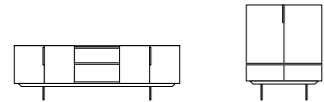

7GE201
Top superiore in marmo
Marble upper top
7GE211
Top superiore in vetro
Glass upper top
L220 P50 H71

7GE202
Top superiore in marmo
Marble upper top
7GE212
Top superiore in vetro
Glass upper top
L100 P50 H125

Finiture Finishes

Top in marmo
Marble top



Code	White Carrara marble OPP1	Black Marquina marble OPP2	Brown Emperador marble OPP3	Grey Serena stone OPP4	Beige Brera stone OPP5	Calacatta gold marble OPP7	Black and gold marble OPP9	Perfetto brown marble OPP10	Grey Stone marble OPP11	Guatemala green marble OPP12
-------------	-------------------------------------	--------------------------------------	---------------------------------------	----------------------------------	----------------------------------	--------------------------------------	--------------------------------------	---------------------------------------	-----------------------------------	--

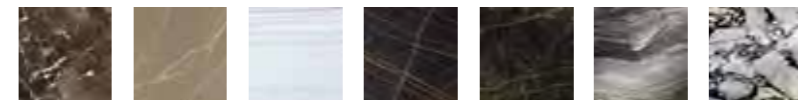

Code	Velvet brown marble OPP13	Amani Bronze marble OPP14	Covelano white marble OPP15	Sahara noir marble OPP16	Port Laurent marble OPP17	Arabescato orobico grey marble OPP20	Calacatta violet marble OPP21
-------------	-------------------------------------	-------------------------------------	---------------------------------------	------------------------------------	-------------------------------------	--	---

Top in Gres Porcellanato
Porcelain Stoneware Top



Code	Nero Marquina OPG2	Statuario Select OPG3	Calacatta Royal OPG4
-------------	------------------------------	---------------------------------	--------------------------------

Top in vetro
Glass top



Code	Transparent glass OPV1	Frosted glass OPV2	RAL 9016 traffic white back-painted glass OPV3	RAL 9017 traffic black back-painted glass OPV4	RAL 7044 silk grey back-painted glass OPV5	RAL 1019 grey beige back-painted glass OPV6	Chrome back-painted bronze glass OPV9	Chrome back-painted grey glass OPV10	Transparent bronze glass OPV12	Transparent grey glass OPV13
-------------	----------------------------------	------------------------------	--	--	--	---	---	--	--	--

Struttura madia/credenza
Sideboard/cupboard structure



Code	Cherry stained oak OPR1	Wengé stained oak OPR2	Walnut stained oak OPR3	Natural oak OPR4	Black stained oak OPR5	Cherry Milano stained oak OPR6
-------------	-----------------------------------	----------------------------------	-----------------------------------	----------------------------	----------------------------------	--

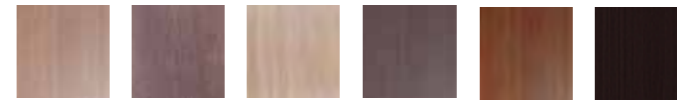

Code	Tobacco stained oak OPR8	Grey taupe stained oak OPR9	Whitened oak OPR10	Charcoal stained oak OPR11	Mahogany stained oak OPR12	Moka matt stained oak OPR15
-------------	------------------------------------	---------------------------------------	------------------------------	--------------------------------------	--------------------------------------	---------------------------------------

Base in metallo
Metal base



Code	Shiny chrome metal OPM1	Brushed matt chrome metal OPM2	Brushed matt dark grey metal OPM3	RAL 9017 black painted metal OPM6	RAL 9016 white painted metal OPM7	Classic bronze painted metal OPM9	Golden beach painted metal OPM10	Gold pearl painted metal OPM11	Brushed copper metal OPM12
-------------	-----------------------------------	--	---	---	---	---	--	--	--------------------------------------



Code	Brushed antique brass metal OPM13	Shiny black chrome metal OPM14	Brushed antique gold metal OPM15	Shiny brass chrome metal OPM16	Bronze metal OPM17	Anodyc Bronze metal OPM18
-------------	---	--	--	--	------------------------------	-------------------------------------

Fusto in legno multistrato di pioppo curvato. Struttura della seduta in legno multistrato con imbottitura in poliuretano espanso a quote differenziate 30 kg/m³ e 40 kg/m³, rivestito in dacron, con cinghie elastiche intrecciate. Rivestimento fisso. La versione standard è dotata di antiscivolanti in PVC. Disponibili a richiesta altri tipi di antiscivolanti, in feltro e plastica.

Carcasse en bois multiplis de peuplier courbé. Structure de l'assise en bois multiplis finie de mousse de polyuréthane de différentes densités de 30 kg/m³ et de 40 kg/m³ couverte de dacron, muni de bandes élastiques entrecroisées. Revêtement fixe. Equipé de patins en PVC dans la version standard. Disponible sur demande avec d'autres patins, en feutre ou en plastique.

Frame made of curved multi-ply poplar wood. Seat structure made of multi-ply wood, upholstered with polyurethane foam in different densities of 30 Kg/m³ and 40 Kg/m³, covered with dacron, with interwoven elastic belts. Fixed covers. The standard version is equipped with PVC glides. Other kinds of glides in plastic or felt pads are available on demand.

Для производства каркаса используется гнутая многослойная фанера из тополя. Конструкция сиденья выполнена из многослойной фанеры в сочетании с перекрещивающимися эластичными ремнями и наполнением из вспененного пенополиуретана различной степени плотности - 30 кг/м³ и 40 кг/м³, обернутого в дакрон. Чехлы несъемные. В стандартный комплект по умолчанию входят противоскользящие накладки из ПВХ. По запросу возможно их изготовление из войлока или пластика.

Das Gestell besteht aus gebogenem Pappelschichtholz. Sitzstruktur aus Schichtholz, gepolstert mit Polyurethan-Schaumstoff in verschiedenen Dichten 30 Kg/m³ und 40 Kg/m³, mit Dacron ummantelt, mit geflochtenen Gummigurten. Nicole ist immer festbezogen. Standard mit PVC-Gleitern ausgestattet. Andere Gleiter, wie Feltz- oder Kunststoffgleiter, sind auf Anfrage verfügbar.

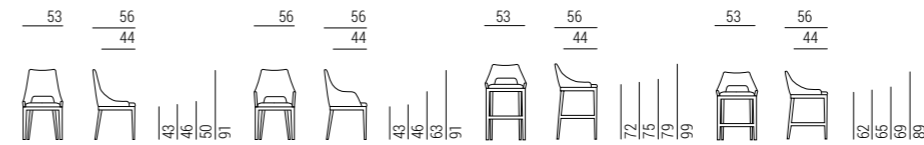

Poltrone Armchairs



9GR101
L53 P56 H91



9GR102
L56 P56 H91



9GR103
L53 P56 H74



9GR104
L53 P56 H99



9GR105
L53 P56 H89

Finiture Finishes

Base in legno
Wooden base



Code
Cherry stained oak **OPR1** | Wengé stained oak **OPR2** | Walnut stained oak **OPR3** | Natural oak **OPR4** | Black stained oak **OPR5** | Cherry Milano stained oak **OPR6**



Code
Tobacco stained oak **OPR8** | Grey taupe stained oak **OPR9** | Whitened oak **OPR10** | Charcoal stained oak **OPR11** | Mahogany stained oak **OPR12** | Moka matt stained oak **OPR15**

Poggiapiedi in metallo
Metal footrest



Code
Shiny chrome metal **OPM1** | Brushed matt chrome metal **OPM2** | Brushed matt dark grey metal **OPM3** | RAL 9017 traffic black painted metal **OPM6** | Classic bronze painted metal **OPM9** | Golden beach painted metal **OPM10**



Code
Gold pearl painted metal **OPM11** | Brushed copper metal **OPM12** | Brushed antique brass metal **OPM13** | Brushed antique gold metal **OPM15** | Anodic bronze metal **OPM18** | Dark bronze painted metal **OPM21**

Tavolini Coffee tables



7KY101
Top marmo/Marble top
7KY102
Top vetro/Glass top
Ø40 H48



7KY103
Top marmo/Marble top
7KY104
Top vetro/Glass top
Ø50 H38



7KY105
Top marmo/Marble top
7KY106
Top vetro/Glass top
Ø50 H48

Top: vetro extra light temperato, spessore 6 mm
Top: extralight tempered glass, 6 mm thick

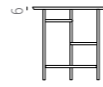

Top: marmo, spessore 20 mm
Top: marble, 20 mm thick



7KY107
Top marmo/Marble top
7KY108
Top vetro/Glass top
Ø80 H38



7KY109
Top marmo/Marble top
7KY110
Top vetro/Glass top
Ø100 H38

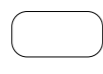

7KY111
Top marmo/Marble top
7KY112
Top vetro/Glass top
L120 P60 H38



7KY113
Top marmo/Marble top
7KY114
Top vetro/Glass top
L80 P80 H38

Tavoli da pranzo Dining tables



7KY201
Top marmo/Marble top
7KY202
Top legno/Wooden top
L200 P110 H74



7KY203
Top marmo/Marble top
7KY204
Top legno/Wooden top
L220 P110 H74



7KY205
Top marmo/Marble top
7KY206
Top legno/Wooden top
L250 P110 H74

Madia Sideboard

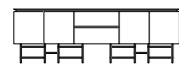

7KY207
Top superiore in marmo
Marble upper top
7KY307
Top superiore in vetro
Glass upper top
L220 P50 H71

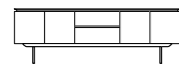

7KY212
Top superiore in marmo
Marble upper top
7KY312
Top superiore in vetro
Glass upper top
L220 P50 H71



7KY208
Top superiore in marmo
Marble upper top
7KY308
Top superiore in vetro
Glass upper top
L220 P50 H50

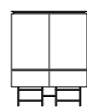

7KY209
Top superiore in marmo
Marble upper top
7KY309
Top superiore in vetro
Glass upper top
L100 P50 H125

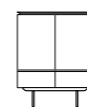

7KY211
Top superiore in marmo
Marble upper top
7KY311
Top superiore in vetro
Glass upper top
L100 P50 H125



7KY210
Top superiore in marmo
Marble upper top
7KY310
Top superiore in vetro
Glass upper top
L100 P50 H105

Credenza Cupboard

Finiture Finishes

Top in marmo
Marble top



Code
White Carrara marble **OPP1** Black Marquina marble **OPP2** Brown Emperador marble **OPP3** Grey Serena stone **OPP4** Beige Brera stone **OPP5** Calacatta gold marble **OPP7** Black and gold marble **OPP9** Perfetto brown marble **OPP10** Grey Stone marble **OPP11** Guatemala green marble **OPP12**

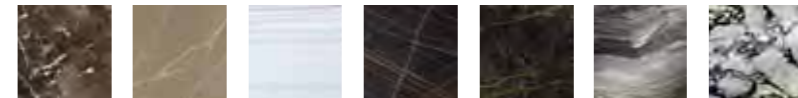

Code
Velvet brown marble **OPP13** Amani Bronze marble **OPP14** Covelano white marble **OPP15** Sahara noir marble **OPP16** Port Laurent marble **OPP17** Arabescato orobico grey marble **OPP20** Calacatta violet marble **OPP21**

Top in Gres Porcellanato
Porcelain Stoneware Top

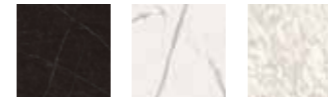

Code
Nero Marquina **OPG2** Statuario Select **OPG3** Calacatta Royal **OPG4**

Top in vetro
Glass top



Code
Transparent glass **OPV1** Frosted glass **OPV2** RAL 9016 traffic white back-painted glass **OPV3** RAL 9017 traffic black back-painted glass **OPV4** RAL 7044 silk grey back-painted glass **OPV5** RAL 1019 grey beige back-painted glass **OPV6** Chrome back-painted bronze glass **OPV9** Chrome back-painted grey glass **OPV10** Transparent bronze glass **OPV12** Transparent grey glass **OPV13**

Top in rovere impiallacciato
Struttura media/credenza
Oak veneer top
Sideboard/cupboard
structure



Code
Cherry stained oak **OPR1** Wengé stained oak **OPR2** Walnut stained oak **OPR3** Natural oak **OPR4** Black stained oak **OPR5** Cherry Milano stained oak **OPR6**



Code
Tobacco stained oak **OPR8** Grey taupe stained oak **OPR9** Whitened oak **OPR10** Charcoal stained oak **OPR11** Mahogany stained oak **OPR12** Moka matt stained oak **OPR15**

Base e puntali in metallo
Metal base and tips

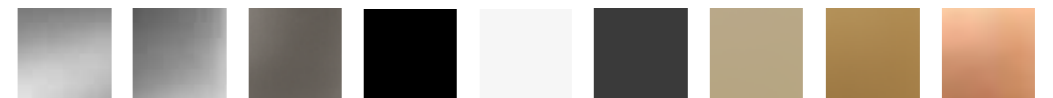

Code
Shiny chrome metal **OPM1** Brushed matt chrome metal **OPM2** Brushed matt dark grey metal **OPM3** RAL 9017 black painted metal **OPM6** RAL 9016 white painted metal **OPM7** Classic bronze painted metal **OPM9** Golden beach painted metal **OPM10** Gold pearl painted metal **OPM11** Brushed copper metal **OPM12**



Code
Brushed antique brass metal **OPM13** Shiny black chrome metal **OPM14** Brushed antique gold metal **OPM15** Shiny brass chrome metal **OPM16** Bronze metal **OPM17** Anodyc Bronze metal **OPM18** Dark bronze painted metal **OPM21**

Fusto in legno massello e legno multistrato con cinghie elastiche intrecciate. Imbottitura in poliuretano espanso rivestito in vellutino bianco. Cuscini di schienale in Piumafib, una speciale miscela ipoallergenica di vera piuma e fibra poliestere siliconata*. Cuscini di seduta costituiti da un inserto in poliuretano con densità di 30 Kg/m³ ricoperto da un trapuntino di vera piuma imbottito a scomparti*. Completamente sfoderabile in tessuto, non sfoderabile in pelle e finta pelle. Kit letto non disponibile.

*Manutenzione dei cuscini contenenti piuma: I cuscini contenenti piuma tendono a deformarsi con l'utilizzo. Per mantenerne la forma è necessario, anche dopo un breve utilizzo, battere e sprimacciare ripetutamente i cuscini. Non utilizzare mai battipanni o aspirapolvere. A coloro che non desiderassero seguire queste indicazioni o che volessero un divano dall'aspetto meno vissuto, raccomandiamo di preferire dei cuscini in gomma.

Carcasse en bois massif et multiplis muni de bandes élastiques entrecroisées et finie de mousse polyuréthane couverte de dacron. Coussins de dossier en Piumafib, un mélange hypoallergénique spécial de véritable duvet et fibre polyester siliconisée.*

Les coussins d'assise sont composés d'un noyau en mousse polyuréthane d'une densité de 30 kg/m³ couvert de véritable duvet matelassé en compartiments.*

Revêtement complètement déhoussable en tissu, fixe en cuir et cuir look. Pas disponible en canapé-lit.
*Entretien de coussins en duvet: Coussins en duvet ont tendance à perdre leur forme dû à l'usage. Pour en conserver la forme il est nécessaire, aussi après un usage court, de régulièrement battre les coussins. Ne jamais utiliser la tapette ou l'aspirateur. A ceux qui ne désirent pas suivre ces indications ou qui souhaitent un canapé qui ait l'air moins "usé", nous conseillons vivement de choisir des coussins en mousse polyuréthane.

Frame made of solid wood and multi-ply wood with interwoven elastic straps. The upholstery is made of polyurethane foam, covered with dacron. The back cushions are filled with Piumafib, a special hypoallergenic mixture of feathers and siliconised polyfibre. The seat cushions are made of a foam insert with density of 30 Kg/m³, covered with a feather compartments quilt*. Fully removable fabric covers, fixed leather and artificial leather covers.*

Sofa-bed is not available.
*Maintenance of feather cushions: Cushions filled with feathers tend to change their shape with use. In order to keep their shape it is necessary, even after a short use, to plump up the cushions repeatedly. Never use carpet beater or vacuum cleaner. We recommend to choose foam cushions to those who do not wish to follow these instructions or to have a "used look" sofa.

Для производства каркаса используется массив дерева и многослойная фанера в сочетании с перекрещивающимися эластичными ремнями. Наполнение из полиуретана, обернутого в белый бархат. Наполнение подушек спинки выполнено из материала Piumafib – специальной, не вызывающей аллергию смеси из натурального пуха и полиэфирных силиконовых волокон. Подушки сиденья: стеганые по отсекам, наполнение из натурального пуха с вставками из полиуретана плотностью 30 кг/м³ *. Полностью съемные чехлы из ткани, несъемные чехлы из кожи. Исполнение дивана в версии со спальным местом: возможно*

Das Gestell besteht aus Massiv- und Schichtholz, mit geflochtenen Gummigurten, gepolstert mit Polyurethanschaumstoff, mit Dacron bezogen. Rueckenkissen aus Piumafib, einer hypoallergischen speziellen Mischung aus echter Daune und silikonisierter Polyesterfaser. Die Sitzkissen bestehen aus einem Schaumkern mit Dichte 30 Kg/m³ mit einer gekammerten Daunenauflage*. Stoffbezüge alle abziehbar, Leder und Kunstleder festbezogen. Als Bettsofa nicht verfügbbar.*

**Wartungsanleitungen fuer Daunenkissen: Die Kissen, die Daunen enthalten, neigen dazu, sich durch Gebrauch zu verformen. Um die urspruengliche Form zu halten, ist es notwendig, auch nach kurzem Gebrauch, die Kissen wiederholt aufzuschueteln. Keinen Auskloepfer oder Staubsauger verwenden. Unseren Kunden, die diese Anweisungen nicht befolgen moechten, oder die kein Sofa mit solchem "gebrauchten" Aussehen haben moechten, empfehlen wir Polyurethan-Kissen.*

**Эксплуатация подушек с пуховым наполнением: В процессе эксплуатации подушки с пуховым наполнением могут деформироваться, во избежание чего их необходимо слегка взбивать вручную даже после непродолжительного нахождения на диване. Использование в этих целях пылесоса или выбивалки для одежды категорически запрещено. Если клиент не планирует следовать данным инструкциям и хочет, чтобы подушки сиденья и спинки проминались по минимуму, посоветуйте выбрать наполнение только из полиуретана, полностью исключив натуральный пух.*

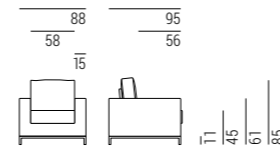

Divani
Sofas

Elementi componibili
Modular elements



4LAN101L
L88 P95 H85

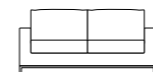

4LAN202L
L180 P95 H85

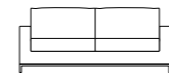

4LAN203L
L200 P95 H85

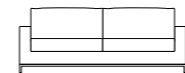

4LAN204L
L220 P95 H85

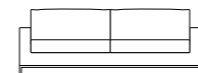

4LAN205L
L240 P95 H85

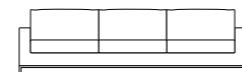

4LAN206L
L300 P95 H85



4LAN213L
L185 P95 H85

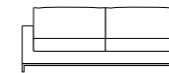

4LAN214L
L205 P95 H85

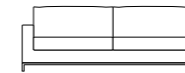

4LAN215L
L225 P95 H85

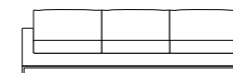

4LAN216L
L285 P95 H85

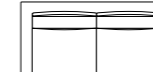

4LAN106
L225 P95 H85

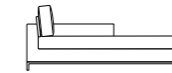

4LAN108L
L180 P95 H85



4LAN107
L95 P95 H45

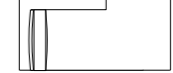

Lancaster Quilted

DESIGN
STUDIO MARELLI
2009

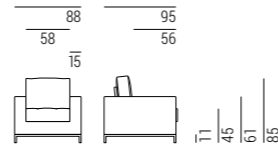

Lancaster

DESIGN
STUDIO MARELLI
2009

Divani
Sofas

Elementi componibili
Modular elements



4LAN101
L88 P95 H85



4LAN202
L180 P95 H85



4LAN213
L185 P95 H85

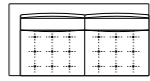

4LAN106
L225 P95 H85

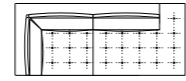

4LAN107
L95 P95 H45



4LAN203
L200 P95 H85



4LAN214
L205 P95 H85

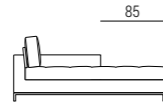
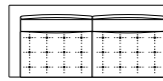

4LAN108
L180 P95 H85

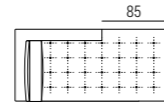

4LAN204
L220 P95 H85



4LAN215
L225 P95 H85

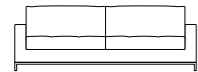
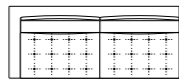

4LAN205
L240 P95 H85



4LAN216
L285 P95 H85

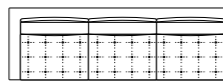

4LAN206
L300 P95 H85

Finiture
Finishes

Base in metallo
Metal base



Code
Shiny chrome metal **OPM1**
Brushed matt chrome metal **OPM2**
Brushed matt dark grey metal **OPM3**
RAL 9017 black painted metal **OPM6**
Classic bronze painted metal **OPM9**
Golden beach painted metal **OPM10**
Gold pearl painted metal **OPM11**



Code
Brushed copper metal **OPM12**
Brushed antique brass metal **OPM13**
Brushed antique gold metal **OPM15**
Shiny brass chrome metal **OPM16**
Bronze metal **OPM17**
Anodyc Bronze painted metal **OPM18**
Dark bronze painted metal **OPM21**

Leaf

DESIGN
STUDIO MARELLI
2009

308

LIFESTYLE COLLECTION N.2 _ MARELLI

Tavoli
Tables



7LE101
Server in metallo
Metal server
L64 P25 H51

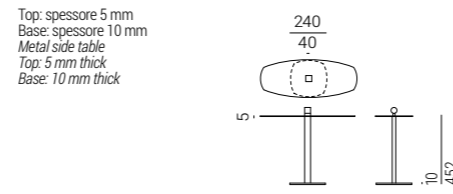

Top: spessore 5 mm
Base: spessore 10 mm
Metal side table
Top: 5 mm thick
Base: 10 mm thick

Finiture
Finishes

Metallo Metal										
Code	Shiny chrome metal OPM1	Brushed matt chrome metal OPM2	Brushed matt dark grey metal OPM3	RAL 9017 black painted metal OPM6	RAL 9016 white painted metal OPM7	Metal painted in RAL Classic colors OPM8	Classic bronze painted metal OPM9	Golden beach painted metal OPM10	Gold pearl painted metal OPM11	Brushed copper metal OPM12
Code	Brushed antique brass metal OPM13	Shiny black chrome metal OPM14	Brushed antique gold metal OPM15	Shiny brass chrome metal OPM16	Bronze metal OPM17	Anodyc Bronze metal OPM18	Dark bronze painted metal OPM21			

Linda

DESIGN
LUCA ERBA
2022

309

LIFESTYLE COLLECTION N.2 _ MARELLI

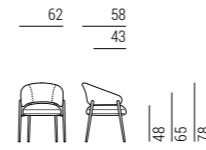

Struttura: tubolare d'acciaio rivestito con schiuma di poliuretano a freddo ignifugo classe 11M
Molleggio di seduta: cinghie elastiche intrecciate.
Rivestimento: non sfoderabile.

Romp: buisstaal bekleed met brandvertragend koudschuim klasse 11M.
Zitvering: door elkaar geweven elastische singels.
Bekleding: vast.

Frame: drawn tubular steel structure upholstered with cold flexible polyurethane foam classified as a class 11M fire-proof material.
Seat springs: intertwined elastic belts.
Cover: not removable.

Несущая конструкция: стальные трубки, покрытые огнеупорным пенополиуретаном, нанесенным холодным способом, класса 11M
Пружинение сиденья: плетеные эластичные ремни.
Покрывтие: не снимается.

Gestell aus gezogenem Stahlrohr, Polsterung aus kaltgeschäumtem, weichem PUR-Schaum, Feuerwiderstands Klasse 11M.
Sitzfederung: geflochtene elastische Gurte.
Bezug: nicht abziehbar.

Poltrone
Armchairs



9LIN101
L62 P58 H78
Base in metallo verniciato
Base in painted metal



9LIN102
L62 P58 H78
Base in metallo spazzolato oro antico OPM15
OPM15 antique gold brushed metal base

Finiture
Finishes

Base e puntali in metallo Metal base and tips										
Code	RAL 9017 black painted metal OPM6	RAL 9016 white painted metal OPM7	Classic bronze painted metal OPM9	Golden beach painted metal OPM10	Gold pearl painted metal OPM11	Brushed antique gold metal OPM15	Anodyc Bronze metal OPM18	Delabre pewter brushed metal OPM19	Delabre brass brushed metal OPM20	Dark bronze painted metal OPM21

Fusto in legno massello e legno multistrato con cinghie elastiche intrecciate. Imbottitura in poliuretano espanso rivestito in vellutino bianco. Cuscini di schienale in Piumafib, una speciale miscela ipoallergenica di vera piuma e fibra poliestere siliconata*. Cuscini di seduta costituiti da un inserto in poliuretano con densità di 30 Kg/m³ ricoperto da un trapuntino di vera piuma imbottito a scomparti*. Completamente sfoderabile in tessuto, non sfoderabile in pelle e finta pelle.

Kit letto non disponibile.

*Manutenzione dei cuscini contenenti piuma:

I cuscini contenenti piuma tendono a deformarsi con l'utilizzo. Per mantenerne la forma è necessario, anche dopo un breve utilizzo, battere e sprimacciare ripetutamente i cuscini. Non utilizzare mai battipanni o aspirapolvere. A coloro che non desiderassero seguire queste indicazioni o che volessero un divano dall'aspetto meno vissuto, raccomandiamo di preferire dei cuscini in gomma.

Carcasse en bois massif et multiplis muni de bandes élastiques entrecroisées et finie de mousse polyuréthane couverte de dacron. Coussins de dossier en Piumafib, un mélange hypoallergénique spécial de véritable duvet et fibre polyester siliconisée. Les coussins d'assise sont composés d'un noyau en mousse polyuréthane d'une densité de 30 kg/m³ couvert de véritable duvet broché en compartiments*. Revêtement complètement déhoussable en tissu, fixe en cuir et cuir look. Pas disponible en canapé-lit.*

*Entretien de coussins en duvet:

Coussins en duvet ont tendance à perdre leur forme dû à l'usage. Pour en conserver la forme il est nécessaire, aussi après un usage court, de régulièrement battre les coussins. Ne jamais utiliser la tapette ou l'aspirateur. A ceux qui ne désirent pas suivre ces indications ou qui souhaitent un canapé qui ait l'air moins "usé", nous conseillons vivement de choisir des coussins en mousse polyuréthane.

Frame made of solid wood and multi-ply wood with interwoven elastic straps. The upholstery is made of polyurethane foam, covered with dacron. The back cushions are filled with Piumafib, a special hypoallergenic mixture of feathers and siliconised polyfibre. The seat cushions are made of a foam insert with density of 30 Kg/m³, covered with a feather compartments quilt*. Fully removable fabric covers, fixed leather and artificial leather covers. Sofa-bed is not available.*

Sofa-bed is not available.

*Maintenance of feather cushions:

Cushions filled with feathers tend to change their shape with use. In order to keep their shape it is necessary, even after a short use, to plump up the cushions repeatedly. Never use carpet beater or vacuum cleaner. We recommend to choose foam cushions to those who do not wish to follow these instructions or to have a "used look" sofa.

Для производства каркаса используется массив дерева и многослойная фанера в сочетании с перекрещивающимися эластичными ремнями. Наполнение из полиуретана, обернутого в белый бархат. Наполнение подушек спинки выполнено из материала Piumafib – специальной, не вызывающей аллергии смеси из натурального пуха и полиэфирных силиконовых волокон. Подушки сиденья: стеганые по отсекам, наполнение из натурального пуха с вставками из полиуретана плотностью 30 кг/м³ *. Полностью съемные чехлы из ткани, несъемные чехлы из кожи.*

Das Gestell besteht aus Massiv- und Schichtholz, mit geflochtenen Gummigurten, gepolstert mit Polyurethanschaumstoff, mit Dacron bezogen. Rueckenkissen aus Piumafib, einer hypoallergischen speziellen Mischung aus echter Daune und silikonisierter Polyesterfaser. Die Sitzkissen bestehen aus einem Schaumkern mit Dichte 30 Kg/m³ mit einer gekammerten Daunenauflage*. Stoffbezüge alle abziehbar, Leder und Kunstleder festbezogen. Als Bettsofa nicht verfügbar.*

Als Bettsofa nicht verfügbar.

Wartungsanleitungen fuer Daunenkissen:

Die Kissen, die Daunen enthalten, neigen dazu, sich durch Gebrauch zu verformen. Um die ursprüngliche Form zu halten, ist es notwendig, auch nach kurzem Gebrauch, die Kissen wiederholt aufzuschütteln. Keinen Ausklopfer oder Staubsauger verwenden. Unseren Kunden, die diese Anweisungen nicht befolgen moechten, oder die kein Sofa mit solchem "gebrauchten" Aussehen haben moechten, empfehlen wir Polyurethan-Kissen.

Вариант со спальным местом не предусмотрен.

*Эксплуатация подушек с пуховым наполнением:

В процессе эксплуатации подушки с пуховым наполнением могут деформироваться, во избежание чего их необходимо слегка взбивать вручную даже после непродолжительного нахождения на диване. Использование в этих целях пылесоса или выбивалки для одежды категорически запрещено. Если клиент не планирует следовать данным инструкциям и хочет, чтобы подушки сиденья и спинки проминались по минимуму, посоветуйте выбрать наполнение только из полиуретана, полностью исключив натуральный пух.

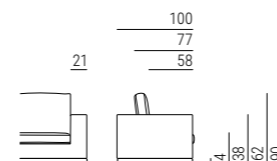

Divani Sofas

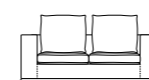

9MU201
L180 P100 H62



9MU202
L200 P100 H62

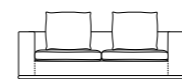

9MU203
L220 P100 H62



9MU204
L240 P100 H62

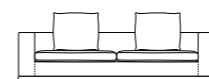

9MU205
L260 P100 H62

Elementi componibili Modular elements

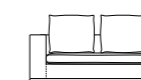

9MU206
L160 P100 H62

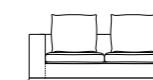

9MU207
L180 P100 H62

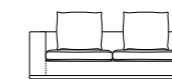

9MU208
L200 P100 H62

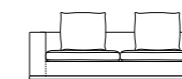

9MU209
L220 P100 H62

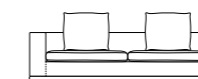

9MU210
L240 P100 H62



9MU212
L140 P100 H62



9MU213
L160 P100 H62



9MU214
L180 P100 H62

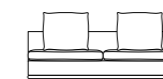

9MU215
L200 P100 H62



9MU216
L100 P100 H62
Elemento angolare
Corner element



9MU220
L80 P100 H62

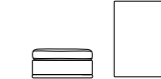

9MU221
L80 P100 H38

Dormeuse
Longchair

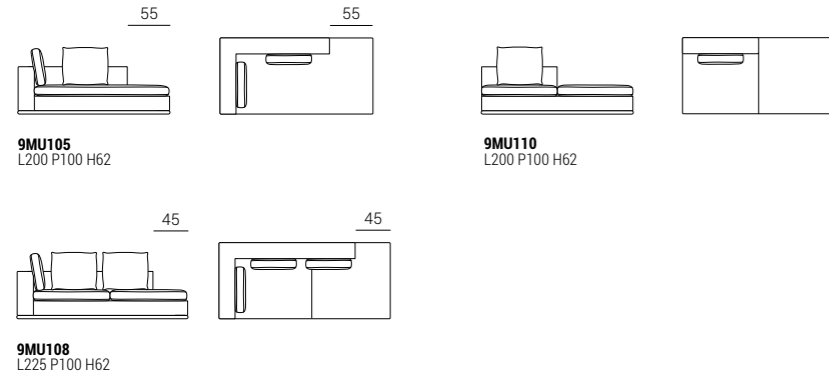

Pouf e accessori
Ottomans and accessories



Finiture base metallo
Metal base finishes

Code	Shiny chrome metal OPM1	Brushed matt chrome metal OPM2	Brushed matt dark grey metal OPM3	RAL 9017 black painted metal OPM6	Classic bronze painted metal OPM9	Golden beach painted metal OPM10	Gold pearl painted metal OPM11	Brushed copper metal OPM12
Code	Brushed antique brass metal OPM13	Shiny black chrome metal OPM14	Brushed antique gold metal OPM15	Shiny brass chrome metal OPM16	Bronze metal OPM17	Anodized bronze metal OPM18	Dark bronze painted metal OPM21	

Tavoli
Tables

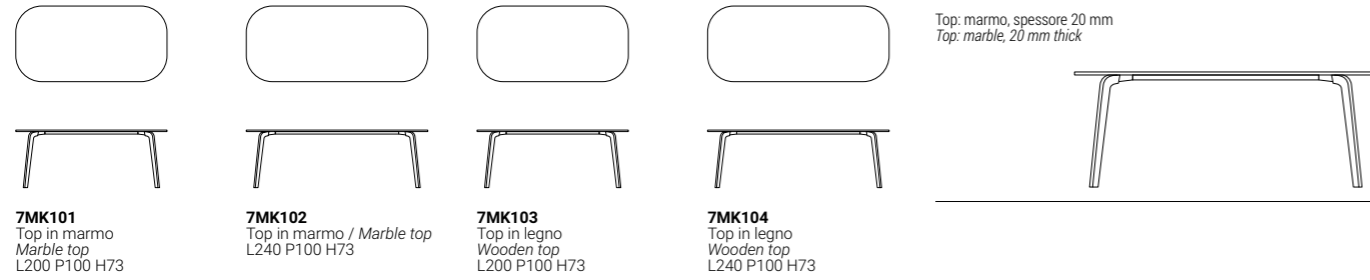

7MK101
Top in marmo
Marble top
L200 P100 H73

7MK102
Top in marmo / Marble top
L240 P100 H73

7MK103
Top in legno
Wooden top
L200 P100 H73

7MK104
Top in legno
Wooden top
L240 P100 H73

Finiture
Finishes

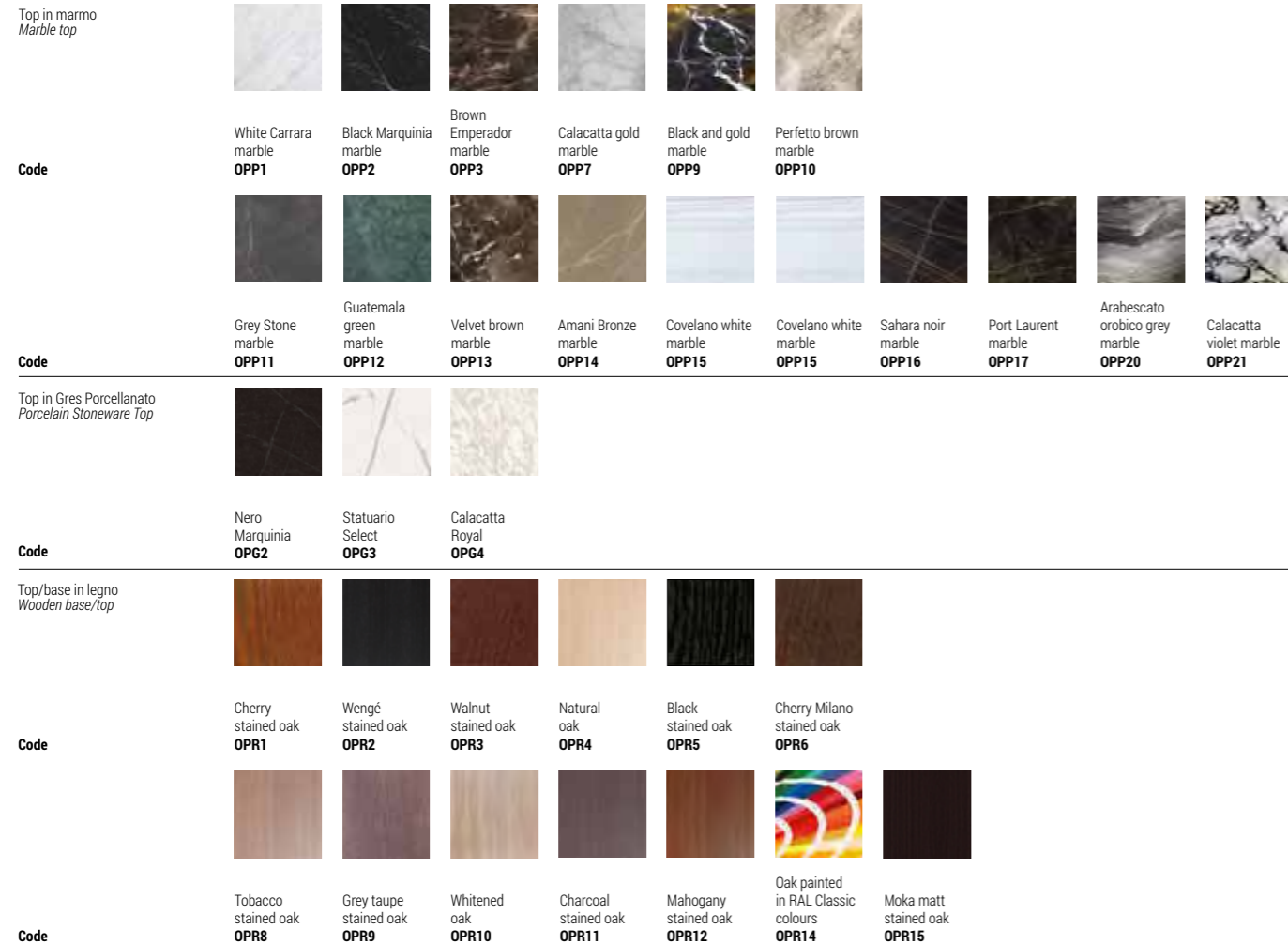

Tavoli
Tables



9TX159
L50 P36 H58

9TX160
L25 P40 H50

Server in metallo, spessore 5 mm
Server table in metal, 5 mm thick

Finiture
Finishes

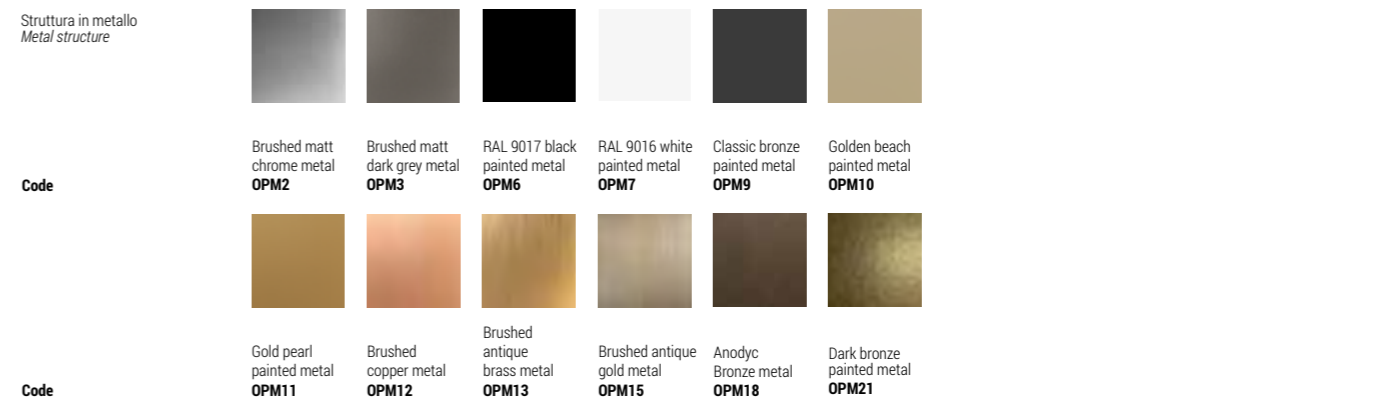

Fusto in legno massello e legno multistrato con cinghie elastiche intrecciate.
Imbottitura della seduta in poliuretano espanso con densità 40 kg/m³ rivestito in dacron.
Imbottitura dello schienale in poliuretano espanso a quote differenziate con densità di 30 kg/m³ e 40 kg/m³, rivestito in dacron.
Rivestimento fisso.

*Carcasse en bois massif et multiplis munie de bandes élastiques entrecroisées.
Assise rembourrée en mousse de polyuréthane d'une densité de 40 kg/m³ couverte de dacron.
Dossier rembourré en mousse polyuréthane de différentes densités de 30 kg/m³ et 40 kg/m³ couverte de dacron.
Revêtement fixe.*

Frame made of solid wood and plywood with interwoven elastic belts.
Seat upholstered with polyurethane foam with density of 40 kg/m³, covered with dacron.
Back upholstered with polyurethane foam with different densities of 30 kg/m³ and 40 kg/m³, covered with dacron.
Fixed covers.

*Для производства каркаса используется массив дерева и многослойная фанера в сочетании с перекрещивающимися эластичными ремнями. Наполнение сиденья из вспененного пенополиуретан плотностью - 30 кг/м³, обернутого в дакрон.
Наполнение спинки из вспененного пенополиуретана различной степени плотности - 30 кг/м³ и 40 кг/м³, обернутого в дакрон.
Чехлы несъемные.*

Das Gestell besteht aus Massiv- und Schichtholz, mit geflochtenen Gummigurten.
Sitz gepolstert mit Polyurethan-Schaumstoff 40 Kg/m³, mit Dacron bezogen.
Rücken gepolstert mit Polyurethan-Schaumstoff in verschiedenen Dichten 30 Kg/m³ und 40 Kg/m³, mit Dacron bezogen.
Ribot ist immer festbezogen.

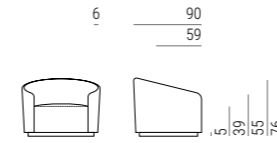

Divani Sofas



9MN101
L98 P90 H76



9MN206
L106 P90 H76



9MN201
L200 P90 H76



9MN207
L156 P90 H76



9MN202
L250 P90 H76

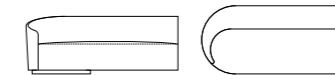

9MN208
L201 P90 H76



9MN203
L245 P120 H76



9MN209
L246 P90 H76



9MN204
L305 P120 H76

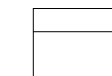

9MN102
Ø60 H40



9CU106
L45 P45

Pouf e accessori Ottomans and accessories



Cuscino in piuma senza fascia
Feather back cushion without band

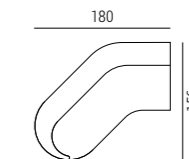

9MN205
L180 P156 H76

Finiture Finishes

Base metallo
Metal base



Code
Shiny chrome metal **OPM1**
Brushed matt chrome metal **OPM2**
Brushed matt dark grey metal **OPM3**
RAL 9017 black painted metal **OPM6**
RAL 9016 white painted metal **OPM7**
Classic bronze painted metal **OPM9**



Code
Golden beach painted metal **OPM10**
Gold pearl painted metal **OPM11**
Brushed antique brass metal **OPM12**
Brushed antique brass metal **OPM13**
Shiny black chrome metal **OPM14**
Brushed antique gold metal **OPM15**
Shiny brass chrome metal **OPM16**
Bronze metal **OPM17**
Anodyc Bronze metal **OPM18**
Dark bronze painted metal **OPM21**

Fusto in legno massello e legno multistrato con cinghie elastiche intrecciate.
Imbottitura della seduta in poliuretano espanso con densità 40 kg/m³ rivestito in dacron.
Imbottitura dello schienale in poliuretano espanso a quote differenziate con densità di 30 kg/m³ e 40 kg/m³, rivestito in dacron.
Rivestimento fisso.

*Carcasse en bois massif et multiplis munie de bandes élastiques entrecroisées.
Assise rembourrée en mousse de polyuréthane d'une densité de 40 kg/m³ couverte de dacron.
Dossier rembourré en mousse polyuréthane de différentes densités de 30 kg/m³ et 40 kg/m³ couverte de dacron.
Revêtement fixe.*

*Frame made of solid wood and plywood with interwoven elastic belts.
Seat upholstered with polyurethane foam with density of 40 kg/m³, covered with dacron.
Back upholstered with polyurethane foam with different densities of 30 kg/m³ and 40 kg/m³, covered with dacron.
Fixed covers.*

*Для производства каркаса используется массив дерева и многослойная фанера в сочетании с перекрещивающимися эластичными ремнями. Наполнение сиденья из вспененного пенополиуретан плотностью - 30 кг/м³, обернутого в дакрон.
Наполнение спинки из вспененного пенополиуретана различной степени плотности - 30 кг/м³ и 40 кг/м³, обернутого в дакрон.
Чехлы несъемные.*

*Das Gestell besteht aus Massiv- und Schichtholz, mit geflochtenen Gummigurten.
Sitz gepolstert mit Polyurethan-Schaumstoff 40 Kg/m³, mit Dacron bezogen.
Rücken gepolstert mit Polyurethan-Schaumstoff in verschiedenen Dichten 30 Kg/m³ und 40 Kg/m³, mit Dacron bezogen.
Ribot ist immer festbezogen.*

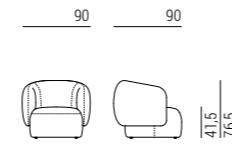

Divani
Sofas



9NH101
L90 P90 H76,5

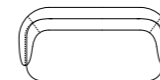

9NH201
L200 P100 H80

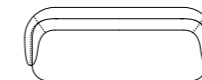

9NH202
L250 P100 H80

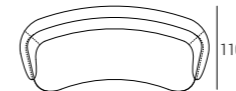

9NH301
L250 P100 H80

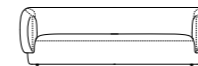

Dormeuse
Longchair

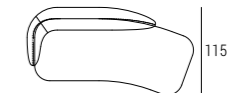

9NH102
L220 P100 H80



Tavoli
Tables

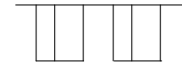
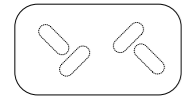

7ON203
Top marmo/Marble top
Base in rovere/Oak base
7ON204
Top marmo/Marble top
Base in MDF/MDF base
L220 P120 H74

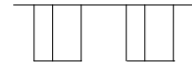
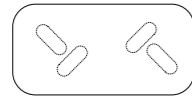

7ON205
Top marmo/Marble top
Base in rovere/Oak base
7ON206
Top marmo/Marble top
Base in MDF/MDF base
L240 P120 H74

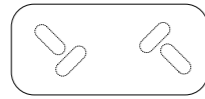

7ON201
Top marmo/Marble top
Base in rovere/Oak base
7ON202
Top marmo/Marble top
Base in MDF/MDF base
L260 P120 H74

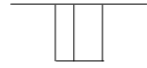
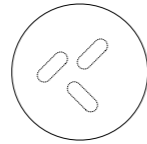

7ON207
Top marmo/Marble top
Base in rovere/Oak base
7ON208
Top marmo/Marble top
Base in MDF/MDF base
ø180 H74

Il tavolo da pranzo Onno è disponibile con top in marmo e base in due versioni:
- base impiallacciato rovere tinto nelle finiture rovere in collezione
- base in MDF verniciato delabré ottone o verniciato nei colori RAL Classic

Onno dining table is available with marble top and base in two versions:
- oak veneer base stained in the oak finishes in collection
- base in MDF painted in delabré brass finish or painted in the RAL Classic colours

Finiture
Finishes

Top in marmo
Marble top



Code
White Carrara marble **OPP1**
Black Marquina marble **OPP2**
Brown Emperador marble **OPP3**
Grey Serena stone **OPP4**
Beige Brera stone **OPP5**
Calacatta gold marble **OPP7**
Black and gold marble **OPP9**
Perfetto brown marble **OPP10**



Code
Grey Stone marble **OPP11**
Velvet brown marble **OPP13**
Amani Bronze marble **OPP14**
Covelano white marble **OPP15**
Sahara noir marble **OPP16**
Port Laurent marble **OPP17**
Arabescato orobico grey marble **OPP20**
Calacatta violet marble **OPP21**

Base in rovere impiallacciato
Oak veneer base



Code
Cherry stained oak **OPR1**
Wengé stained oak **OPR2**
Walnut stained oak **OPR3**
Natural oak **OPR4**
Black stained oak **OPR5**
Cherry Milano stained oak **OPR6**



Code
Tobacco stained oak **OPR8**
Grey taupe stained oak **OPR9**
Whitened oak **OPR10**
Charcoal stained oak **OPR11**
Mahogany stained oak **OPR12**
Moka matt stained oak **OPR15**

Base legno finitura metallo
Wooden base with metal finishing

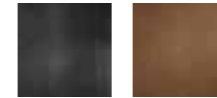

Delabre pewter brushed metal **OPM19**
Delabre brass brushed metal **OPM20**

Base in MDF
MDF base



Painted in RAL Classic colors

Specchi
Mirrors



7RE105
L90 H90



7RE106
L90 H190



7RE107
Ø120

Finiture
Finishes

Struttura in metallo
Metal structure



Code

Brushed matt chrome metal OPM2	Brushed matt dark grey metal OPM3	RAL 9017 black painted metal OPM6	RAL 9016 white painted metal OPM7	Classic bronze painted metal OPM9	Golden beach painted metal OPM10
--	---	---	---	---	--



Code

Gold pearl painted metal OPM11	Brushed copper metal OPM12	Brushed antique brass metal OPM13	Brushed antique gold metal OPM15	Bronze metal OPM17
--	--------------------------------------	---	--	------------------------------

Fusto in legno massello e legno multistrato con cinghie elastiche intrecciate.
Imbottitura in espanso rivestito in vellutino bianco.
Cuscini di schienale in Piumafib, una speciale miscela ipoallergenica di vera piuma e fibra poliestere siliconata*.
Cuscini di seduta in poliuretano espanso con densità di 30 Kg/m³ (su richiesta è possibile avere densità 40 Kg/m³ medio o 40 Kg/m³ morbido), rivestito in fibre termo legate e in tessuto di puro cotone.
Completamente sfoderabile in tessuto, non sfoderabile in pelle e finta pelle.
Kit letto non disponibile.
*Manutenzione dei cuscini contenenti piuma: I cuscini contenenti piuma tendono a deformarsi con l'utilizzo.
Per mantenerne la forma è necessario, anche dopo un breve utilizzo, battere e sprimacciare ripetutamente i cuscini.
Non utilizzare mai battipanni o aspirapolvere.
A coloro che non desiderassero seguire queste indicazioni o che volessero un divano dall'aspetto meno vissuto, raccomandiamo di preferire dei cuscini in gomma.

Carcasse en bois massif et multiplis muni de bandes élastiques entrecroisées et finie de mousse polyuréthane couverte de dacron.
Coussins de dossier en Piumafib, un mélange hypoallergénique spécial de véritable duvet et fibre polyester siliconisée.*
Coussins d'assise en mousse polyuréthane d'une densité de 30 kg/m³ (sur demande, il est possible d'avoir une densité de 40 kg/m³ medium ou 40 kg/m³ souple), couverte de dacron.
Revêtement complètement déhoussable en tissu, fixe en cuir et cuir look.
Pas disponible en canapé-lit.
**Entretien de coussins en duvet: Coussins en duvet ont tendance à perdre leur forme dû à l'usage.*
Pour en conserver la forme il est nécessaire, aussi après un usage court, de régulièrement battre les coussins. Ne jamais utiliser la tapette ou l'aspirateur.
À ceux qui ne désirent pas suivre ces indications ou qui souhaitent un canapé qui ait l'air moins "usé", nous conseillons vivement de choisir des coussins en mousse polyuréthane.

Frame made of solid wood and multi-ply wood with interwoven elastic straps, upholstered with polyurethane foam, covered with dacron.
The back cushions are filled with Piumafib, a special hypoallergenic mixture of feathers and siliconised polyfibre.*
The seat cushions are made of polyurethane foam with density of 30 Kg/m³ (on demand it is possible to have 40 Kg/m³ medium or 40 Kg/m³ soft), covered with dacron and pure cotton fabric.
Fully removable fabric covers, fixed leather and artificial leather covers.
Sofa-bed is not available.
**Maintenance of feather cushions: Cushions filled with feathers tend to change their shape with use.*
In order to keep their shape it is necessary, even after a short use, to plump up the cushions repeatedly. Never use carpet beater or vacuum cleaner.
We recommend to choose foam cushions to those who do not wish to follow these instructions or to have a "used look" sofa.

Каркас из массива дерева и фанеры с переплетенными эластичными ремнями.
Набивка из пены, обтянутая белым велветом.
Подушки спины из Piumafib, специальной гипоаллергенной смеси натурального пуха и силиконизированного полиэфирного волокна.*
Подушки сиденья из пенополиуретана плотностью 30 кг/м³ (плотность 40 кг/м³ medium или 40 кг/м³ soft по запросу), покрытые термоскрепленным волокном и тканью из чистого хлопка.
Полностью съемные чехлы из ткани, не съемные чехлы из кожи и искусственной кожи.
Постельный комплект не поставляется.
**Уход за подушками, содержащими пух: Подушки, содержащие пух, склонны к деформации при использовании.*
Чтобы сохранить их форму, необходимо даже после кратковременного использования неоднократно взбивать и распушивать подушки.
Никогда не используйте выбивалку или пылесос.
Для тех, кто не хочет следовать этим инструкциям или хочет, чтобы диван имел менее изношенный вид, мы рекомендуем резиновые подушки.

Das Gestell besteht aus Massiv- und Schichtholz, mit geflochtenen Gummigurten, gepolstert mit Polyurethanschaumstoff, mit Dacron bezogen.
Rueckenkissen aus Piumafib, einer hypoallergenischen speziellen Mischung aus echter Daune und silikonisierter Polyesterfaser.*
Die Sitzkissen bestehen aus Polyurethan-Schaumstoff 30 Kg/m³ (auf Anfrage kann man 40 Kg/m³ medium oder 40 Kg/m³ weich haben), bezogen mit Dacron und reinem Baumwollstoff.
Stoffbezüge alle abziehbar, Leder und Kunstleder festbezogen.
Als Bettsofa nicht verfuegbar.
**Wartungsanleitungen fuer Daunenkissen: Die Kissen, die Daunen enthalten, neigen dazu, sich durch Gebrauch zu verformen.*
Um die urspruengliche Form zu halten, ist es notwendig, auch nach kurzem Gebrauch, die Kissen wiederholt aufzuschueteln.
Keinen Ausklopfper oder Staubsauger verwenden.
Unseren Kunden, die diese Anweisungen nicht befolgen moechten, oder die kein Sofa mit solchem "gebrauchten" Aussehen haben moechten, empfehlen wir Polyurethan-Kissen.

Richard

DESIGN
STEFANO GALLIZOLI
2023

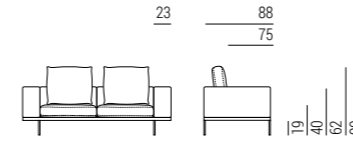
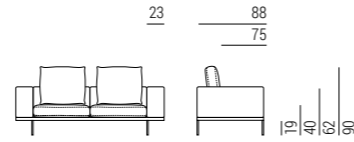

Richard Quilted

DESIGN
STEFANO GALLIZOLI
2023

Dormeuse e accessori
Longchair and accessories

Dormeuse
Longchair

Divani
Sofas

Elementi componibili
Modular elements

Divani
Sofas

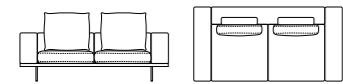

9RIC201
L196 P98 H62

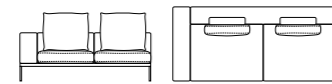

9RIC204
L173 P98 H62

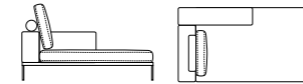

9RIC213
L173 P98 H62

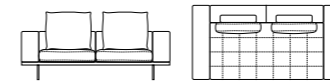

9RCT201
L196 P98 H62

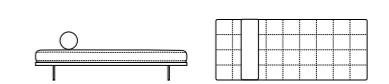

9RIC215
L200 P80 H62

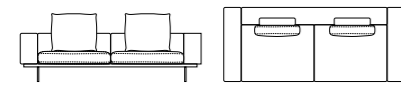

9RIC202
L240 P98 H62

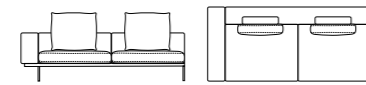

9RIC205
L217 P98 H62



9CU106
L45 P45

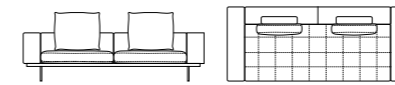

9RCT202
L240 P98 H62

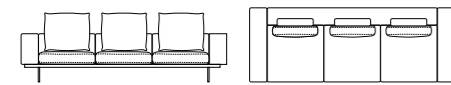

9RIC203
L271 P98 H62



9RIC206
L248 P98 H62



9RIC101
L50 P50

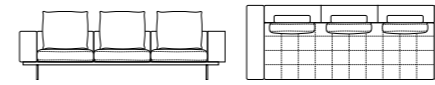

9RCT203
L271 P98 H62

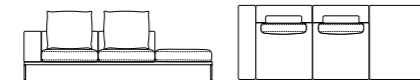

9RIC212
L248 P98 H62

Finiture *Finishes*

Base metallo
Metal base

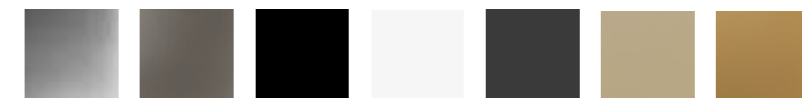

Code

Brushed matt chrome metal **OPM2**
Brushed matt dark grey metal **OPM3**
RAL 9017 black painted metal **OPM6**
RAL 9016 white painted metal **OPM7**
Classic bronze painted metal **OPM9**
Golden beach painted metal **OPM10**
Gold pearl painted metal **OPM11**



Code

Brushed copper metal **OPM12**
Brushed antique brass metal **OPM13**
Brushed antique gold metal **OPM15**
Anodyc Bronze metal **OPM18**
Dark bronze painted metal **OPM21**
Prosecco painted metal **OPM22**
Tobacco painted metal **OPM23**

Fusto in legno massello e legno multistrato con cinghie elastiche intrecciate. Imbottitura in espanso rivestito in vellutino bianco. Cuscini di schienale in piuma*. Cuscini di seduta costituiti da un inserto in poliuretano con densità di 30 Kg/m³, ricoperto da un trapuntino di vera piuma imbottito a scomparti*. Cuscini di seduta e schienale sfoderabili, struttura fissa, non sfoderabile. Kit letto non disponibile. *Manutenzione dei cuscini contenenti piuma: I cuscini contenenti piuma tendono a deformarsi con l'utilizzo. Per mantenerne la forma è necessario, anche dopo un breve utilizzo, battere e sprimacciare ripetutamente i cuscini. Non utilizzare mai battipanni o aspirapolvere. A coloro che non desiderassero seguire queste indicazioni o che volessero un divano dall'aspetto meno vissuto, raccomandiamo di preferire dei cuscini in gomma.

Car casse en bois massif et multiplis muni de bandes élastiques entrecroisées et finie de mousse polyuréthane couverte de dacron. Coussins de dossier en duvet. Coussins d'assise composés d'un noyau en mousse polyuréthane d'une densité de 30 kg/m³, couvert de véritable duvet broché en compartiments*. Coussins de dossier et d'assise déhoussables, structure fixe, non déhoussable. Pas disponible en canapé-lit. *Entretien de coussins en duvet: Coussins en duvet ont tendance à perdre leur forme dû à l'usage. Pour en conserver la forme il est nécessaire, aussi après un usage court, de régulièrement battre les coussins. Ne jamais utiliser la tapette ou l'aspirateur. A ceux qui ne désirent pas suivre ces indications ou qui souhaitent un canapé qui ait l'air moins "usé", nous conseillons vivement de choisir des coussins en mousse polyuréthane.*

Frame made of solid wood and multi-ply wood with interwoven elastic straps, upholstered with polyurethane foam, covered with dacron. Feather back cushions. The seat cushions are made of a foam insert with density of 30 Kg/m³, covered with a feather compartments quilt*. Seat and back cushions with removable covers, fixed structure, non removable. Sofa-bed is not available. *Maintenance of feather cushions: Cushions filled with feathers tend to change their shape with use. In order to keep their shape it is necessary, even after a short use, to plump up the cushions repeatedly. Never use carpet beater or vacuum cleaner. We recommend to choose foam cushions to those who do not wish to follow these instructions or to have a "used look" sofa.*

Каркас из массива дерева и фанеры с переплетенными эластичными ремнями. Обивка из пены, покрытая белым вельветом. Подушки спины из пера. Подушки сиденья, состоящие из полиуретановой вставки плотностью 30 кг/м³, покрытой стеганым одеялом из натурального пуха*. Подушки сиденья и спинки со съёмными чехлами, фиксированная конструкция, не снимается. Комплект постели не поставляется. *Уход за подушками, содержащими пух: Подушки, содержащие пух, склонны к деформации при использовании. Чтобы сохранить их форму, необходимо даже после кратковременного использования неоднократно взбивать и распушивать подушки. Никогда не используйте выбивалку или пылесос. Для тех, кто не хочет следовать этим инструкциям или хочет, чтобы диван имел менее изношенный вид, мы рекомендуем резиновые подушки.*

Das Gestell besteht aus Massiv- und Schichtholz, mit geflochtenen Gummigurten, gepolstert mit Polyurethanschaumstoff, mit Dacron bezogen. Rueckenkissen aus Daunen. Die Sitzkissen bestehen aus einem Schaumkern mit Dichte 30 Kg/m³, mit einer gekammerten Daunenaufgabe*. Sitz- und Rueckenkissen mit abnehmbaren Bezuegen, feste Struktur, nicht abnehmbar. Als Bettsofa nicht verfuegbar. *Wartungsanleitungen fuer Daunenkissen: Die Kissen, die Daunen enthalten, neigen dazu, sich durch Gebrauch zu verformen. Um die urspruegliche Form zu halten, ist es notwendig, auch nach kurzem Gebrauch, die Kissen wiederholt aufzuschuetteln. Keinen Ausklopfper oder Staubsauger verwenden. Unseren Kunden, die diese Anweisungen nicht befolgen moechten, oder die kein Sofa mit solchem "gebrauchten" Aussehen haben moechten, empfehlen wir Polyurethan-Kissen.*

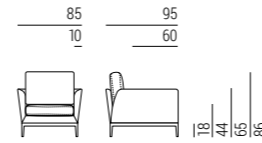

Divani Sofas



9RIT101
L85 P95 H86

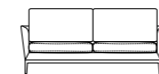

9RIT201
L190 P95 H86

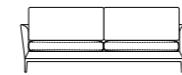

9RIT202
L220 P95 H86

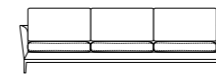

9RIT203
L275 P95 H86

Elementi componibili Modular elements

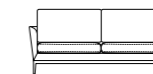

9RIT204
L180 P95 H86

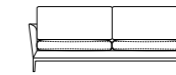

9RIT205
L210 P95 H86

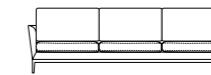

9RIT206
L265 P95 H86

Dormeuse Longchair

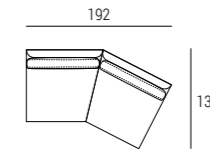

9RIT208
L192 P132 H86

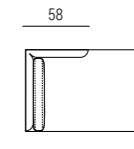

9RIT207
L108 P152 H86

Finiture Finishes

Base metallo
Metal base

Code

Code

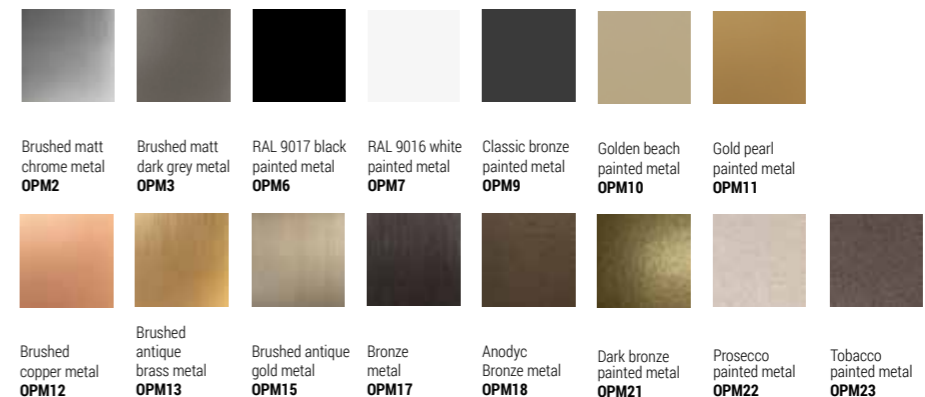

Schienale in legno multistrato di pioppo curvato imbottito con poliuretano espanso con densità 30 kg/m³. Seduta in legno multistrato di pioppo imbottito con poliuretano espanso 40 kg/m³, rivestito in dacron con cinghie elastiche intrecciate. Rivestimento fisso.

Dossier en bois multiplis de peuplier courbé fini de mousse de polyuréthane de densité de 30 kg/m³. Structure de l'assise en bois multiplis de peuplier finie de mousse de polyuréthane de densité de 40 kg/m³ couverte de dacron, muni de bandes élastiques entrecroisées. Revêtement fixe.

Backrest made of curved multi-ply poplar wood, upholstered with polyurethane foam with density 30 kg/m³. Seat structure made of multi-ply poplar wood, upholstered with polyurethane foam with density of 40 kg/m³, covered with dacron, with interwoven elastic belts. Fixed covers.

Для изготовления спинки используется гнутая многослойная фанера из тополя с наполнением из вспененного полиуретана плотностью 30 кг/м³. Конструкция сиденья: многослойная фанера из тополя с наполнением из вспененного полиуретана плотностью 40 кг/м³, обернутого в дакрон, в сочетании с перекрещивающимися эластичными ремнями. Обивка несъемная.

Rückenlehne aus aus gebogenem Pappelschichtholz, gepolstert mit Polyurethan-Schaumstoff mit Dichte 30 Kg/m³. Sitzstruktur aus Pappelschichtholz, gepolstert mit Polyurethan-Schaumstoff mit Dichte 40 Kg/m³, mit Dacron ummantelt, mit geflochtenen Gummigurten. Sign ist immer festbezogen.

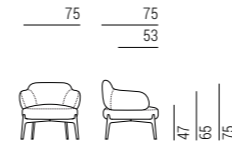

Divani Sofas



9SI101
Poltrona girevole/Swivel armchair
L83 P75 H75



9SI112
Base in metallo/Metal base
L83 P75 H75

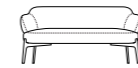

9SI211
Base in metallo/Metal base
L160 P75 H75

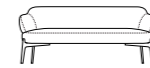

9SI212
Base in metallo/Metal base
L180 P75 H75



9SI102
Base in legno/Wood base
L83 P75 H75

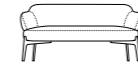

9SI201
Base in legno/Wood base
L160 P75 H75

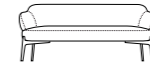

9SI202
Base in legno/Wood base
L180 P75 H75

Finiture Finishes

Base in metallo
+ base in metallo girevole
Metal base
+ swivel metal base



Code
Shiny chrome metal **OPM1**
Brushed matt chrome metal **OPM2**
Brushed matt dark grey metal **OPM3**
RAL 9017 black painted metal **OPM6**
RAL 9016 white painted metal **OPM7**
Classic bronze painted metal **OPM9**
Golden beach painted metal **OPM10**
Gold pearl painted metal **OPM11**



Code
Brushed copper metal **OPM12**
Brushed antique brass metal **OPM13**
Shiny black chrome metal **OPM14**
Brushed antique gold metal **OPM15**
Shiny brass chrome metal **OPM16**
Bronze metal **OPM17**
Anodyc Bronze painted metal **OPM18**
Dark bronze painted metal **OPM21**

Base in legno
Wooden base























Code
Cherry stained oak **OPR1**
Wengé stained oak **OPR2**
Walnut stained oak **OPR3**
Natural oak **OPR4**
Black stained oak **OPR5**
Cherry Milano stained oak **OPR6**





































Code
Tobacco stained oak **OPR8**
Grey taupe stained oak **OPR9**
Whitened oak **OPR10**
Charcoal stained oak **OPR11**
Mahogany stained oak **OPR12**
Moka matt stained oak **OPR15**

Tavoli
Tables

 	 	 	 	 	 	 	 	 	 
<p>7TH101 Tavolo in marmo / Marble table 7TH201 Tavolo in finitura metallo OPM19/OPM20 Table in metal finish OPM19/OPM20 L80 P80 H19</p>	<p>7TH102 Tavolo in marmo Marble table 7TH202 Tavolo in finitura metallo OPM19/OPM20 Table in metal finish OPM19/OPM20 L100 P100 H19</p>	<p>7TH111 Tavolo in marmo con base metallo Marble table with metal base 7TH211 Tavolo in finitura metallo OPM19/OPM20 Table in metal finish OPM19/OPM20 L80 P80 H27</p>	<p>7TH112 Tavolo in marmo con base metallo Marble table with metal base 7TH212 Tavolo in finitura metallo OPM19/OPM20 Table in metal finish OPM19/OPM20 L100 P100 H27</p>	<p>7TH103 Tavolo in marmo Marble table 7TH203 Tavolo in finitura metallo OPM19/OPM20 Table in metal finish OPM19/OPM20 L40 P40 H40</p>	<p>7TH104 Tavolo in marmo Marble table 7TH204 Tavolo in finitura metallo OPM19/OPM20 Table in metal finish OPM19/OPM20 L50 P50 H50</p>	<p>7TH105 Tavolo in marmo Marble table 7TH205 Tavolo in finitura metallo OPM19/OPM20 Table in metal finish OPM19/OPM20 L60 P60 H19</p>	<p>7TH115 Tavolo in marmo con base metallo Marble table with metal base 7TH215 Tavolo in finitura metallo OPM19/OPM20 Table in metal finish OPM19/OPM20 L60 P60 H27</p>	<p>7TH106 Tavolo in marmo Marble table 7TH206 Tavolo in finitura metallo OPM19/OPM20 Table in metal finish OPM19/OPM20 L60 P110 H19</p>	<p>7TH116 Tavolo in marmo con base metallo Marble table with metal base 7TH216 Tavolo in finitura metallo OPM19/OPM20 Table in metal finish OPM19/OPM20 L60 P110 H27</p>

Finiture
Finishes

Marmo Marble										
Code	White Carrara marble OPP1	Black Marquina marble OPP2	Brown Emperador marble OPP3	Grey Serena stone OPP4	Beige Brera stone OPP5	Calacatta gold marble OPP7	Black and gold marble OPP9	Perfetto brown marble OPP10	Grey Stone marble OPP11	Guatemala green marble OPP12
										
Code	Velvet brown marble OPP13	Amani Bronze marble OPP14	Covelano white marble OPP15	Sahara noir marble OPP16	Port Laurent marble OPP17	Arabescato orobico grey marble OPP20	Calacatta violet marble OPP21			
Base in metallo Metal base										
Code	Shiny chrome metal OPM1	Brushed matt chrome metal OPM2	Brushed matt dark grey metal OPM3	RAL 9017 black painted metal OPM6	RAL 9016 white painted metal OPM7	Classic bronze painted metal OPM9	Golden beach painted metal OPM10	Gold pearl painted metal OPM11		
										
Code	Brushed copper metal OPM12	Brushed antique brass metal OPM13	Shiny black chrome metal OPM14	Brushed antique gold metal OPM15	Shiny brass chrome metal OPM16	Bronze metal OPM17	Anodized Bronze metal OPM18	Dark bronze painted metal OPM21		
Tavolo in finitura metallo Table in metal finish										
Code	Delabre pewter brushed metal OPM19	Delabre brass brushed metal OPM20								

Tavoli
Tables

 7TG101 Top in marmo/Marble top 7TG111 Top in metallo/Metal top 7TG121 Top in rovere massello/Solid oak top Ø50 H50 7TG131 Top in vetro/Glass top Ø50 H50	 7TG102 Top in marmo/Marble top 7TG112 Top in metallo/Metal top 7TG122 Top in rovere massello/Solid oak top Ø60 H40 7TG132 Top in vetro/Glass top Ø60 H40	 7TG103 Top in marmo/Marble top 7TG113 Top in metallo/Metal top 7TG123 Top in rovere massello/Solid oak top Ø100 H35 7TG133 Top in vetro/Glass top Ø100 H35	 7TG104 Top in marmo/Marble top 7TG114 Top in metallo/Metal top 7TG124 Top in rovere massello/Solid oak top L120 P71 H35 7TG144 Top in vetro/Glass top L120 P71 H35	Top: marmo/rovere massello, spessore 20 mm Base: tubo di metallo rotondo, sezione 10 mm Top: marble/solid oak, 20 mm thick Base: square metal tube, section 10 mm	 20
 7TG139 Top in marmo/Marble top 7TG140 Top impiallacciato rovere Oak veneer top Ø120 H74	 7TG130 Top in marmo/Marble top 7TG150 Top impiallacciato rovere Oak veneer top L180 P110 H74	 7TG134 Top in marmo/Marble top 7TG135 Top impiallacciato rovere Oak veneer top 7TG138 Top in vetro/Glass top L240 P110 H74	 7TG136 Top in marmo/Marble top L300 P120 H74 7TG137 Top impiallacciato rovere Oak veneer top 7TG143 Top in vetro/Glass top L310 P120 H74	Top: metallo, spessore 10 mm Base: tubo di metallo rotondo, sezione 10 mm Top: metal, 10 mm thick Base: square metal tube, section 10 mm	 10

Finiture in vetro per tavoli e tavolini
Glass finishes for tables and coffee tables

Top in vetro per 7TG138 e 7TG143
Glass top 7TG138 and 7TG143

Code Transparent glass OPV1	Code Frosted glass OPV2	Code RAL 9016 traffic white back-painted glass OPV3	Code RAL 9017 traffic black back-painted glass OPV4	Code RAL 7044 silk grey back-painted glass OPV5	Code RAL 1019 grey beige back-painted glass OPV6	Code Chrome back-painted bronze glass OPV9	Code Chrome back-painted grey glass OPV10	Code Transparent bronze glass OPV12	Code Transparent grey glass OPV13

finiture vetri per i tavolini
Glass finishes for coffee tables

Code RAL 9016 traffic white back-painted glass OPV3	Code RAL 7044 silk grey back-painted glass OPV5	Code RAL 1019 grey beige back-painted glass OPV6	Code Chrome back-painted bronze glass OPV9	Code Chrome back-painted grey glass OPV10

Finiture
Finishes

Top in marmo Marble top										
Code	White Carrara marble OPP1	Black Marquina marble OPP2	Brown Emperador marble OPP3	Grey Serena stone OPP4	Beige Brera stone OPP5	Calacatta gold marble OPP7	Black and gold marble OPP9	Perfetto brown marble OPP10	Grey Stone marble OPP11	Guatemala green marble OPP12
	Velvet brown marble OPP13	Amani Bronze marble OPP14	Covelano white marble OPP15	Sahara noir marble OPP16	Port Laurent marble OPP17	Arabescato orobico grey marble OPP20	Calacatta violet marble OPP21			
Top in Gres Porcellanato Porcelain Stoneware Top										
Code	Nero Marquina OPG2	Statuario Select OPG3	Calacatta Royal OPG4							
Top in legno Wooden top										
Code	Cherry stained oak OPR1	Wengé stained oak OPR2	Walnut stained oak OPR3	Natural oak OPR4	Black stained oak OPR5	Cherry Milano stained oak OPR6				
Code	Tobacco stained oak OPR8	Grey taupe stained oak OPR9	Whitened oak OPR10	Charcoal stained oak OPR11	Mahogany stained oak OPR12	Moka matt stained oak OPR15				
Top in metallo Metal top										
Code	Brushed matt dark grey metal OPM3	Classic bronze painted metal OPM9	Golden beach painted metal OPM10	Gold pearl painted metal OPM11	Brushed copper metal OPM12	Brushed antique brass metal OPM13	Brushed antique gold metal OPM15	Anodyc Bronze metal OPM18	Dark bronze painted metal OPM21	
Base in metallo Metal base										
Code	Shiny chrome metal *OPM1	Brushed matt chrome metal OPM2	Brushed matt dark grey metal OPM3	RAL 9017 traffic black painted metal OPM6	Classic bronze painted metal OPM9	Golden beach painted metal OPM10	Gold pearl painted metal OPM11	Brushed copper metal OPM12	Brushed antique brass metal OPM13	
Code	Shiny black chrome metal *OPM14	Brushed antique gold metal OPM15	Shiny brass chrome metal *OPM16	Bronze metal OPM17	Anodyc Bronze metal OPM18	Dark bronze painted metal OPM21				

* non disponibile per i tavoli 7TG137 e 7TG143
* not available for 7TG137 and 7TG143 tables

Wave

DESIGN
LUCA ERBA
2021

Wave Dining Table

DESIGN
LUCA ERBA
2022

334

LIFESTYLE COLLECTION N.2 _ MARELLI

Tavoli Tables



Top: rovere impiallacciato o marmo, spessore 20 mm
Base: tubo di metallo quadrato, sezione 15 mm
Top: oak veneer or marble, 20 mm thick
Base: square metal tube, section 15 mm



Top in vetro extralight, temperato, spessore 6 mm
Base: tubo di metallo quadrato, sezione 15 mm
Top: extralight tempered glass, 6 mm thick
Base: square metal tube, section 15 mm

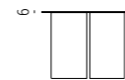
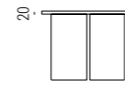

7WA101
Top marmo/Marble top
7WA111
Top vetro/Glass top
ø50 H47

7WA102
Top marmo/Marble top
7WA112
Top vetro/Glass top
ø60 H37

7WA103
Top marmo/Marble top
7WA113
Top vetro/Glass top
ø100 H27

7WA104
Top marmo/Marble top
7WA114
Top vetro/Glass top
ø120 H27

Finiture Finishes

Top in marmo
Marble top



White Carrara marble **OPP1** Black Marquina marble **OPP2** Brown Emperador marble **OPP3** Grey Serena stone **OPP4** Beige Brera stone **OPP5** Calacatta gold marble **OPP7** Black and gold marble **OPP9** Perfetto brown marble **OPP10** Grey Stone marble **OPP11** Guatemala green marble **OPP12**

Top in marmo
Marble top



Velvet brown marble **OPP13** Amani Bronze marble **OPP14** Covelano white marble **OPP15** Sahara noir marble **OPP16** Port Laurent marble **OPP17** Arabescato orobico grey marble **OPP20** Calacatta violet marble **OPP21**

Top in Gres Porcellanato
Porcelain Stoneware Top



Nero Marquina **OPG2** Statuario Select **OPG3** Calacatta Royal **OPG4**

Top in vetro
Glass top



RAL 9016 traffic white back-painted glass **OPV3** RAL 9017 traffic black back-painted glass **OPV4** RAL 7044 silk grey back-painted glass **OPV5** RAL 1019 grey beige back-painted glass **OPV6** Chrome back-painted bronze glass **OPV9** Chrome back-painted grey glass **OPV10**

Base in metallo
Metal Base

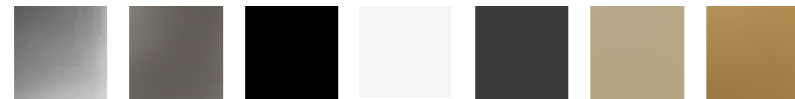

Brushed matt chrome metal **OPM2** Brushed matt dark grey metal **OPM3** RAL 9017 black painted metal **OPM6** RAL 9016 white painted metal **OPM7** Classic bronze painted metal **OPM9** Golden beach painted metal **OPM10** Gold pearl painted metal **OPM11**



Brushed copper metal **OPM12** Brushed antique brass metal **OPM13** Brushed antique gold metal **OPM15** Delabre pewter brushed metal **OPM19** Delabre brass brushed metal **OPM20** Dark bronze painted metal **OPM21** Prosecco painted metal **OPM22** Tobacco painted metal **OPM23**

335

LIFESTYLE COLLECTION N.2 _ MARELLI

Tavoli Tables

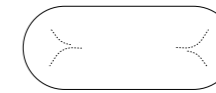
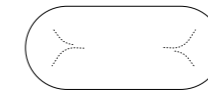
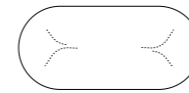

7WA204
Top marmo/Marble top
7WA214
Top vetro/Glass top
ø160 H747

7WA202
Top marmo/Marble top
7WA212
Top vetro/Glass top
L240 P110 H74

7WA201
Top marmo/Marble top
7WA211
Top vetro/Glass top
L260 P110 H74

7WA203
Top marmo/Marble top
7WA213
Top vetro/Glass top
L280 P110 H74

Finiture Finishes

Top in marmo
Marble top



White Carrara marble **OPP1** Black Marquina marble **OPP2** Brown Emperador marble **OPP3** Grey Serena stone **OPP4** Beige Brera stone **OPP5** Calacatta gold marble **OPP7** Black and gold marble **OPP9** Perfetto brown marble **OPP10** Grey Stone marble **OPP11** Guatemala green marble **OPP12**

Top in marmo
Marble top

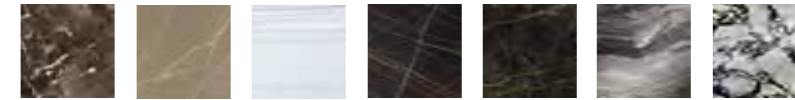

Velvet brown marble **OPP13** Amani Bronze marble **OPP14** Covelano white marble **OPP15** Sahara noir marble **OPP16** Port Laurent marble **OPP17** Arabescato orobico grey marble **OPP20** Calacatta violet marble **OPP21**

Top in Gres Porcellanato
Porcelain Stoneware Top



Nero Marquina **OPG2** Calacatta Royal **OPG4**

Base in metallo
Metal Base



Brushed matt chrome metal **OPM2** Brushed matt dark grey metal **OPM3** RAL 9017 black painted metal **OPM6** RAL 9016 white painted metal **OPM7** Classic bronze painted metal **OPM9** Golden beach painted metal **OPM10** Gold pearl painted metal **OPM11** Brushed copper metal **OPM12**



Brushed antique brass metal **OPM13** Brushed antique gold metal **OPM15** Anodyc bronze metal **OPM18** Delabre pewter brushed metal **OPM19** Delabre brass brushed metal **OPM20** Dark bronze painted metal **OPM21** Prosecco painted metal **OPM22** Tobacco painted metal **OPM23**

graphic

Matteo Paoloni

concept and stylist creator

Morena Colombo

photo

IKB Studio

all rights reserved © 2023

marelli**Giulio Marelli Italia SpA**

Via Indipendenza 159 20821 Meda (MB) Italia

T ++39 0362 342116

info@giuliomarelli.com www.giuliomarelli.com



marelli

Giulio Marelli Italia SpA

Via Indipendenza 159 20821 Meda (MB) Italia T ++39 0362 342116
info@giuliomarelli.com www.giuliomarelli.com